

DANCOVER[®]



Manual
for
Polytunnel Greenhouse
5,4m Series

DANCOVER[®]

.com

Safety Advice

Attention

In some countries or areas, you may have to obtain permission when setting up structures like greenhouses or similar buildings exceeding a certain size. It is your responsibility to comply with local rules and regulations and to ensure that the greenhouse is assembled correctly.

Please note that your polytunnel greenhouse is intended as a seasonal form of coverage and not as a permanent structure! During windy weather, we advise you to secure your greenhouse or in case of strong wind, take it down. Overall, we advise you to place your polytunnel greenhouse in the lee of a building, trees or other objects that will protect the greenhouse from too strong and direct wind.

When it rains, water may pile up on top of your polytunnel greenhouse causing it to collapse. It is your responsibility to keep the roof of the greenhouse free of gathering water. Be sure that the cover is fully extended at all times and make sure to remove water that builds up during rainfall.

In case of bad weather in general, please secure loose objects in the garden, e.g. the garden trampoline and other things that may cause a danger for your polytunnel greenhouse. Furthermore, do not use open fire, welding equipment or other sources of ignition, inside or close to the greenhouse.

When you buy a greenhouse and set it up in your garden, we recommend that you check, whether your home insurance covers the structure. At the same time, you are not supposed to be inside the greenhouse during extreme weather conditions.

This structure has not been tested for specific snow and wind loads! Make sure you follow our general safety advice and in the event of snow, always remove excessive amounts of snow from the greenhouse to prevent too much snow on the roof of the greenhouse. Snow is likely to make the entire structure to collapse; hence our advice about seasonal use only.









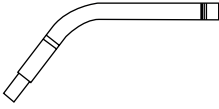

Note: Dancover warranty applies only to the normal use of the greenhouse, normal wear and tear excepted, by written use instructions or manual. The warranty does not apply to damage caused by accident, abuse, misuse or modification of the greenhouse.

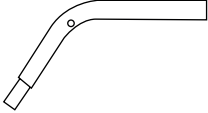
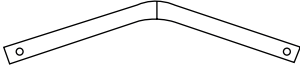
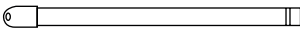
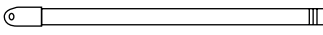
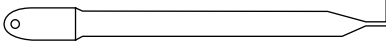
Warranty Information

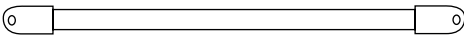

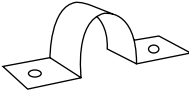
Please visit dancovershop.com for information on warranty.

Please always check our website for the latest safety advice and manual.

PARTLIST FOR 5.4m series

Part no.	Description		6m	7,5m	9m	10,5m
1	Leg		10	12	14	16
2	Female brace 60"		7	7	7	7
3	Corner arch		10	12	14	16
4	Center arch		5	6	7	8
5	Male door rail		5	6	7	8
6	Female door rail		5	6	7	8
7	T-bar		5	6	7	8
8	Male brace 63"		21	28	35	42
9	Diagonal 80"		4	4	4	6
10	Rope		4	4	4	4
14	Floor bracket		8	8	8	8
15	Nail		16	16	16	16
16	Carriage bolt 1 3/4"		22	23	24	25
17	Carriage bolt 2 1/2"		11	13	15	17
18	Carriage bolt 4"		27	33	38	43

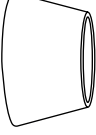
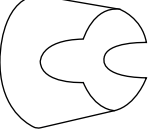
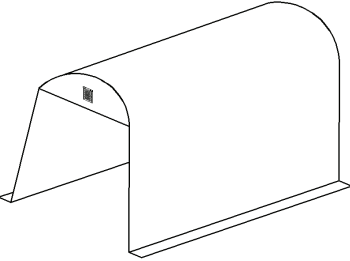
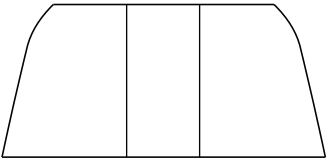
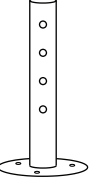
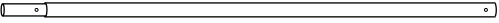
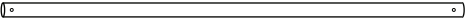
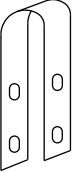
PARTLIST FOR 5.4m series

Part no.	Description		6m	7,5m	9m	10,5m
19	Wing nut		71	82	93	104
20	Big plastic cap for legs		10	12	14	16
21	Small plastic cap for cross pipe		14	14	14	14
22	Roof		1	1	1	1
23/24	Door		2	2	2	2
25	Basefoot		4	4	4	4
26	Doorbar, Male		4	4	4	4
27	Doorbar, Female		4	4	4	4
28	Bracket		4	4	4	4
29	Peg		4	4	4	4

DEAR CUSTOMER

Please use gloves when assembling the metal frame portion of this unit. The metal components of this product have been treated with a rust preventive coating that may feel oily to the touch. This coating is not dangerous, but may dirty your hands during assembly. We recommend that you wipe metal parts clean with a mixture of warm water and dish detergent prior to assembly. Should your hands become dirty, simply wash with soap and water.

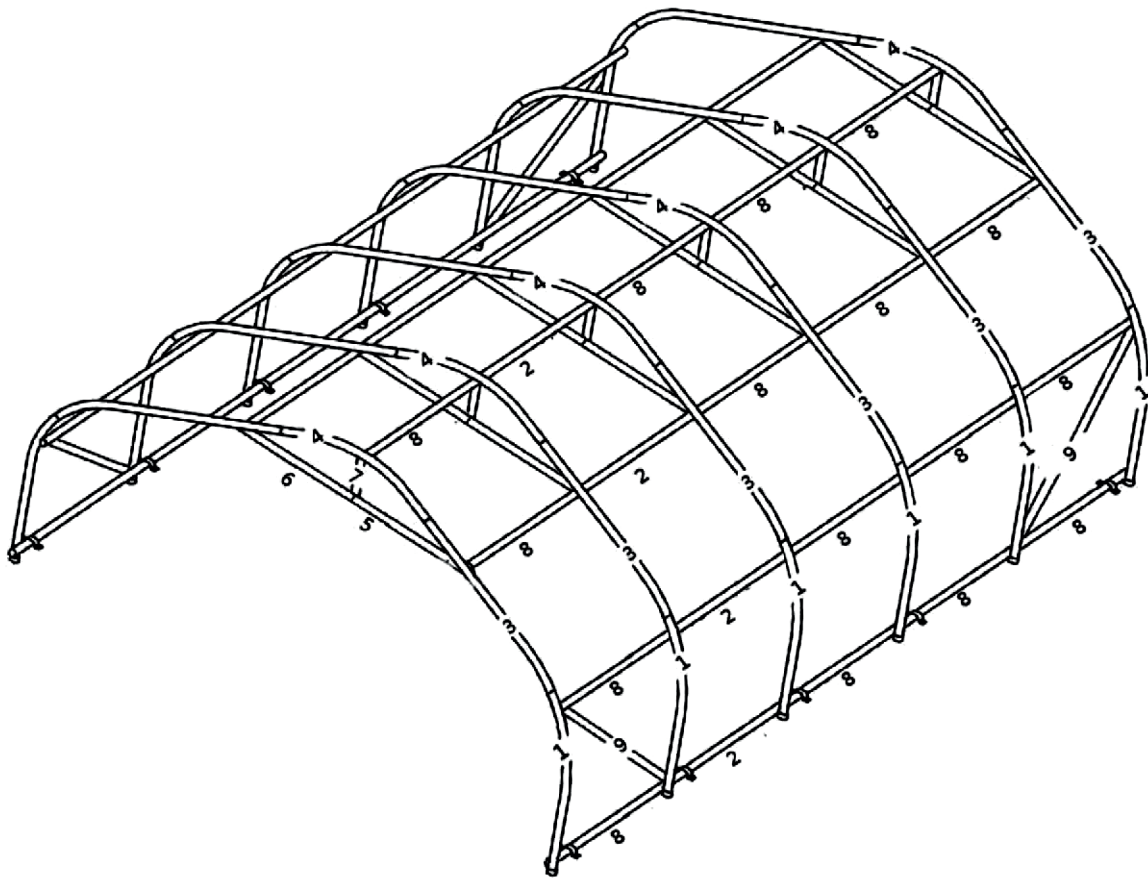

ASSEMBLY INSTRUCTIONS

1. Take a Center Arch (no. 4) and on each end of it, assemble a Corner Arch (no. 3). Secure the Male and Female Door (no. 5) and (no. 6) to the Arch (no. 3).
2. Add the T-Bar (no. 7) to the Door Rails and the Center Arch.

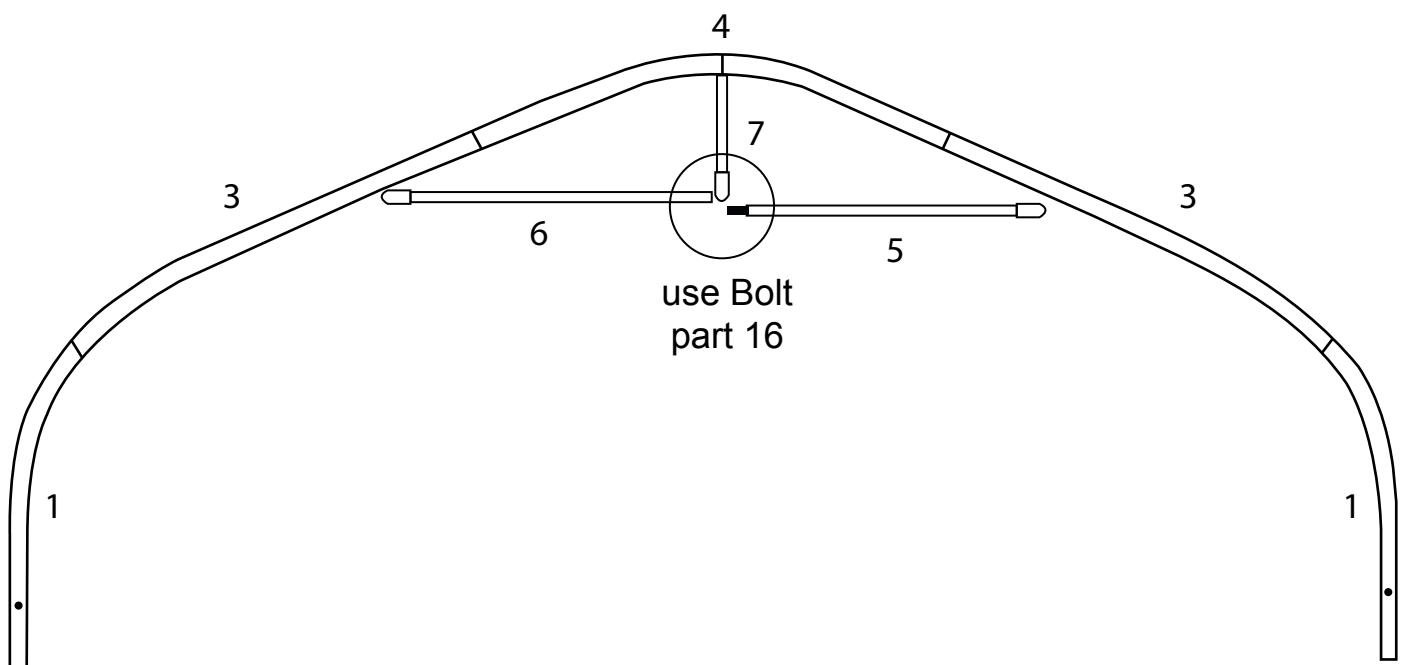

3. On each end of (no. 3), install the Leg (no. 1). Repeat step 1 for all frames.

4. At this point stand up the front or back frame and add 7 male connecting pipes (no. 8). Then stand up another frame and add 7 female connecting pipes (no. 2). For the remaining frames use the male connecting pipes (no. 8).

5. Add the diagonals (no. 9) to the first and last legs (no. 1).

Note: Make sure all screws are tight. Do not over-tighten.

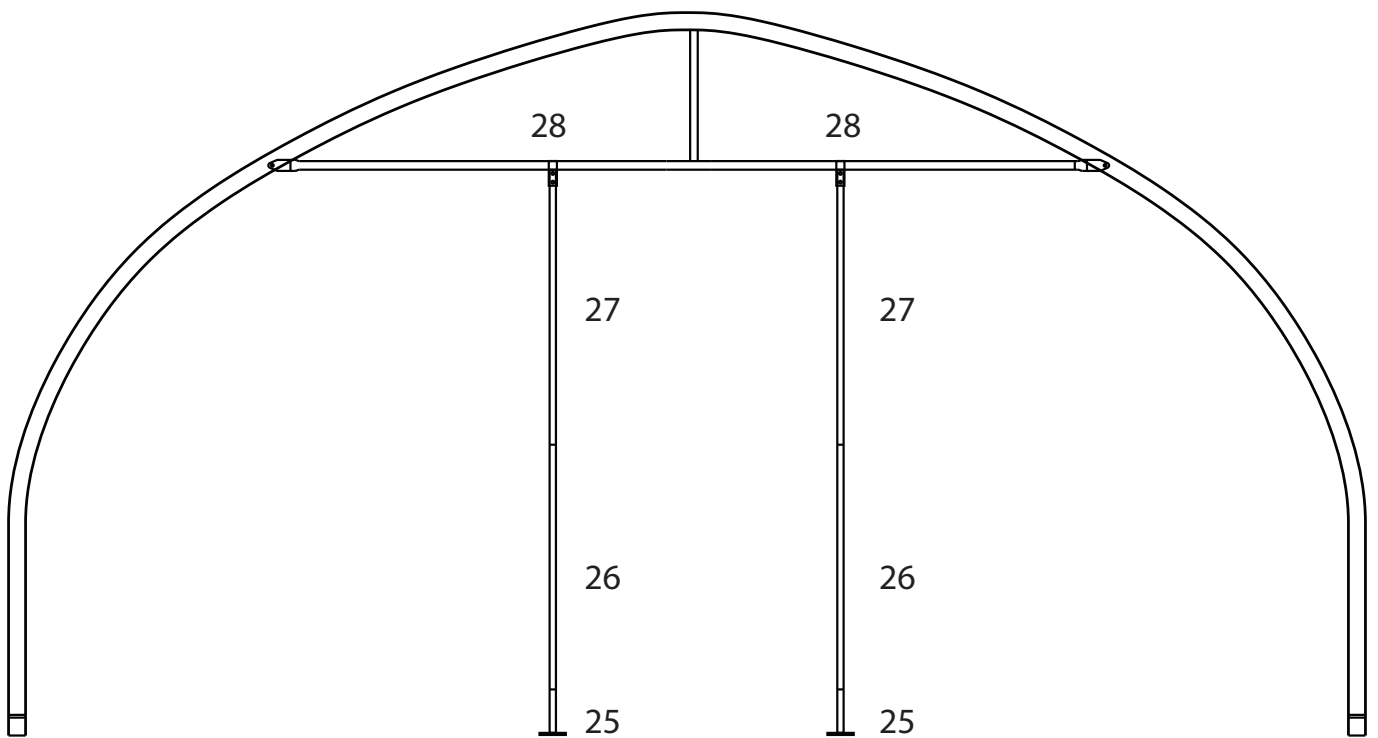
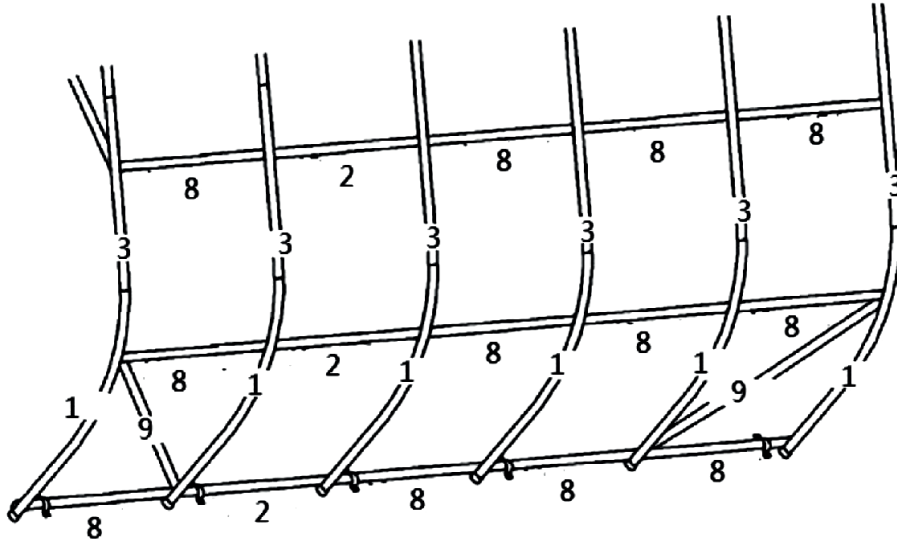

6. ROOF ASSEMBLY

Take the roof and place it over the structure. Make sure that the windows are on the two sides of the shelter, at front or at back as your choice.

Tie all the ropes around the pipes.

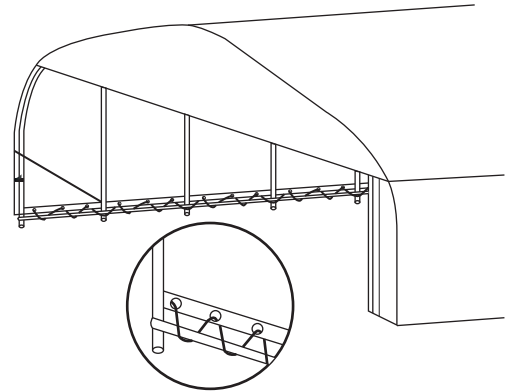

7. SHELTER REINFORCEMENT

Before you install the floor brackets, make sure the distance between the legs is 18 feet wide.

Place the floor brackets (14) at each end of the shelter. Then drive in nails (15) into ground, gravel or asphalt. Other material surfaces require other types of anchoring (cement blocks, sand bags, screw and bolt, etc). Permanent anchors are not provided with this unit.

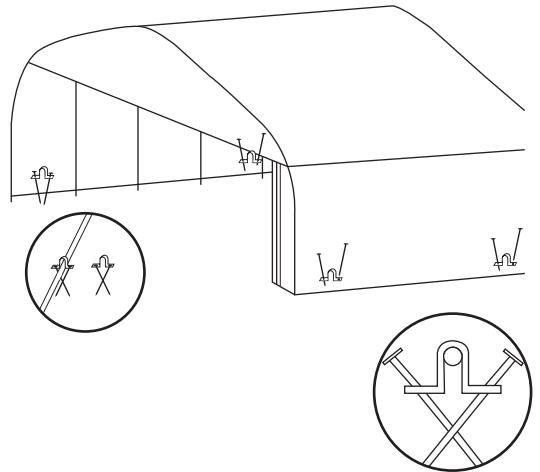

8. DOOR INSTALLATION

Install doorbar at each end, use the bracket (28) to attach the doorbar to the door nail (5.6). Connect door with roof by velcro as shown.

Use strap to attach the doors to the doorbar.

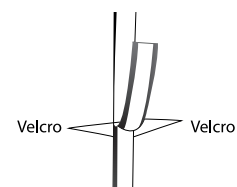

Contact information

Head office:

Dancover A/S
Nordre Strandvej 119 G
3150 Hellebæk
Denmark

For more information
please visit:
www.dancovershop.com

National contact

Denmark: 70 26 76 20
denmark@dancover.com

UK: 020 8099 7570
uk@dancover.com

Germany: 041 0266 7040
germany@dancover.com

France: 0975 181 800
france@dancover.com

Sweden: 040 233 262
sverige@dancover.com

Finland: 0 931 581 720
suomi@dancover.com

Poland: 22 300 8602
polska@dancover.com

Luxembourg: +49 041 0266 7040
luxembourg@dancover.com

Portugal: 308 800 899
portugal@dancover.com

Spain: 911 436 828
espana@dancover.com

Italy: 02 479 21 198
italia@dancover.com

Switzerland: 0840 000125
schweiz@dancover.com

Austria: 0662 626935
austria@dancover.com

Norway: 231 00 690
norge@dancover.com

Nederland: 0 858 880 524
nederland@dancover.com

Ireland: 0 151 33 003
ireland@dancover.com

Belgium: 0 28 08 08 09
belgique@dancover.com