

**DANCOVER<sup>®</sup>**



**Party PRO EventZone**

**6m Series**

# DANCOVER<sup>®</sup>



## Safety Advice

### Attention

In some countries approval is needed to set up a marquee/tent larger than 75 m<sup>2</sup>. It is your responsibility to comply with local rules and regulations and to ensure that the marquee/tent is assembled correctly.

In case of bad weather conditions, it is your responsibility to ensure the marquee/tent is safely secured and that the marquee/tent does not cause damage to others.

Do not use open fire, welding equipment or other sources which can ignite, inside or close to the tent.

The marquee/tent must be safely secured. We recommend you secure your marquee/tent with straps and pegs as soon as it is assembled.

Make sure to check if the marquee/tent is covered by your home contents insurance.

Marquees/tents must be evacuated under extreme weather conditions.

In the event of snow always remove snow from the roof of the marquee/tent regularly to prevent snow from building on the roof as heavy snow can cause the marquee/tent to collapse.

In the event of rain there is a risk of rain puddles building up on top of the roof of the marquee/tent. Heavy rain puddles can cause the roof to collapse. It is your responsibility to ensure rain puddles do not build up. As a precaution, make sure the roof of the marquee/tent is stretched out properly and adequately over the side frames of the marquee/tent and remove rain water regularly.

Do not unpack or repack your marquee/tent in freezing temperatures. In case of temperatures below zero always unpack and repack your marquee/tent indoors to avoid the risk of cracking parts.

The marquee/tent must be totally dry before you repack and store it to avoid mildew.

Note: Marquees are intended for events and other arrangements and are as such only meant for short term temporary assembly and the following disassembly. Dancover warranty applies only to the normal use of the Product, normal wear and tear excepted, in accordance with written use instructions or manual. The warranty does not apply to damage caused by accident, abuse, misuse, or modification of the Product.

### Warranty Information

Please visit [dancovershop.com](http://dancovershop.com) for information on warranty.

*Please always check our website for the latest safety advice and manual.*

---

# Contents

**1. General**

**2. Frames Assembling Guide**

**3. 'Cover and Sidewalls' Assembling Guide**

**4. Part list**

**5. Fundamental**

---

# 1. General

Before assembling, workers should acquaint themselves with the safety precautions, necessary implements and materials.

- **Safety Precautions:**

- A. The supervisor needs at least 6 assistants to set up the tent.
- B. Before starting to work, the supervisor has to make his assistants familiar with the sequence of operations and safety precautions.
- C. He has to check that his assistants are qualified for this job and he is the responsible leader on the site.
- D. Everybody on the site should wear solid shoes and helmets.
- E. The site should be insulated. The people except the workers are not allowed to enter into the site.
- F. If the foundation soil is of an inferior quality, it is necessary to obviate foundation breaking danger by sufficient additional soil compression for expansion of the bearing surface.
- G. Pay attention that the site is free of circuit and that there are no cables or pipes under the ground.
- H. In case any cables or other electric equipment is installed in the tents, electrical operation rules should be strictly executed.
- I. Local safety precautions are applicable.
- J. Make sure the site is safe for the third party part. If the setup works is lasting for sections, safety measures should be taken in the nights.
- K. Tents fixing methods: In case of concrete ground and its heights exceeds 15cm, please use Swell Screws or weight bags. In case of grass ground, bitumen ground (any other soft grounds), please use steel Ground-Anchors.
- L. Please make sure the height difference of the site don't exceed 5cm, otherwise, it will affect the safety of the tent.

- 
- M. During or after the setup, if there is bad weather, especially when hailstone is reported by weather forecast, please dismantle the tent. If the snow depth is equal to or thicker than 3cm, please clean the snow on the roof. If the wind speed is equal to or faster than 80 Km/h, the tent has to be closed completely (all Roof-Cover, Gable-Cover, Sidewall & Gable Wall).
  - N. Any local regulations for temporary building are applicable.
  - O. In case of fire, please unfasten the Rope/Zipper on the wall or open the door to escape.
  - P. In case of any other special case, please contact the manufacturer for consultation.

- **Necessary Implements:**

Ladders, Spanners, Setup-ropes, Forks, Hammer, Pliers, Drills, a Protecting Foil or Carpet, Helmets, Solid shoes, Go-Cart, Pull-Up Peg Machine (if use the Ground-Anchors for tents fixing)

- **Necessary Materials:**

Please kindly find technical data in the packing list in the delivery.

## 2. Frames Assembling Guide

- **Measure the site and mark the tent position**

- Please arrange the face line of one longitudinal side or the face line of the gable side
- Then mark and stake the Base-Plates on the right position (please kindly find the Base-Plates position drawing in the shipping documents).

- **Check the material list and put all of them on the right position for setup (Please find the packing list in the delivery - Techniques of the Tent)**

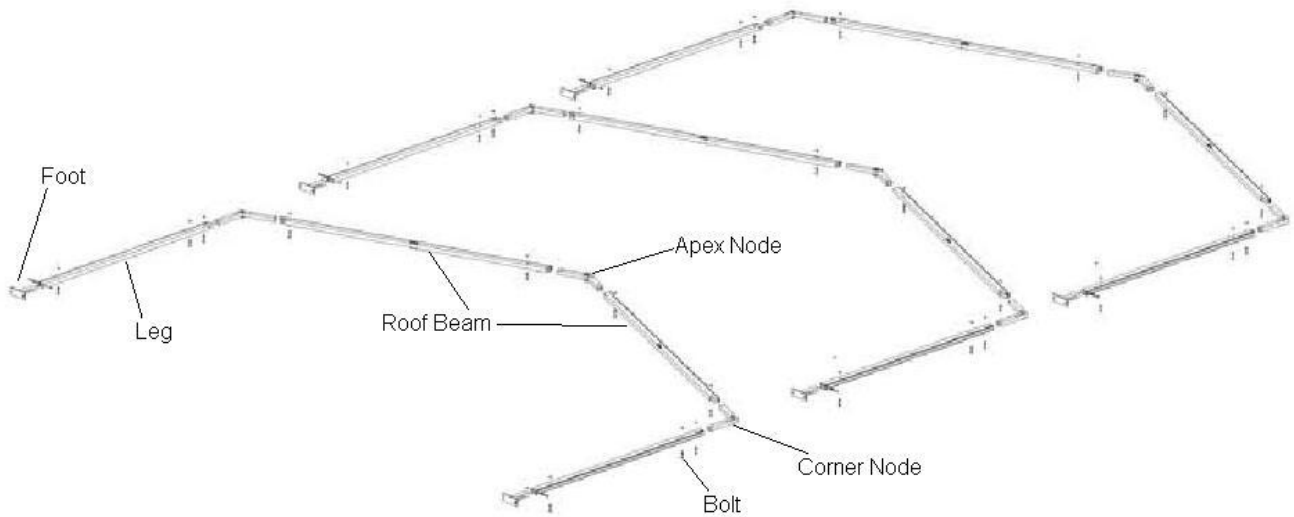

- **Use the bolt to connect the Foot-Plates, Upright-Supports, Roof-Beams, Eave-Connections and Top Connections. And then, erect the first frame of the tent.**

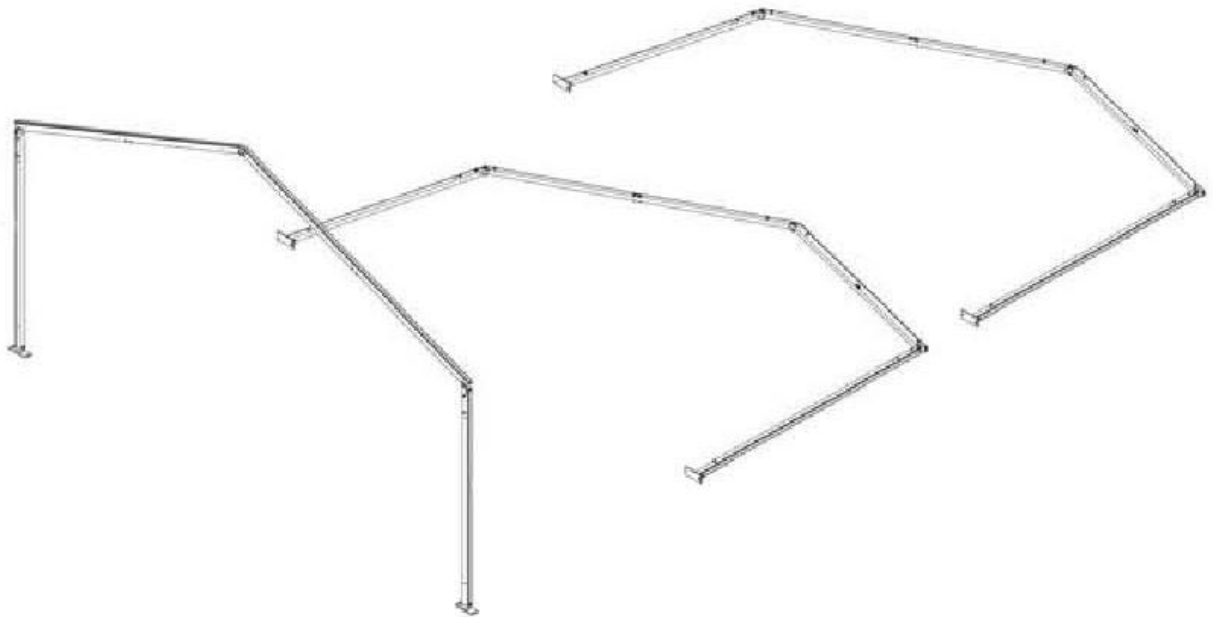

- **Erect the first section:**
  - A. Erect the second frame
  - B. Fix the X-Cross bars by bolts
  - C. Put the Eave-Purlin, Intermediate-Purlin and Roof-Purlin on the Roof-Beams

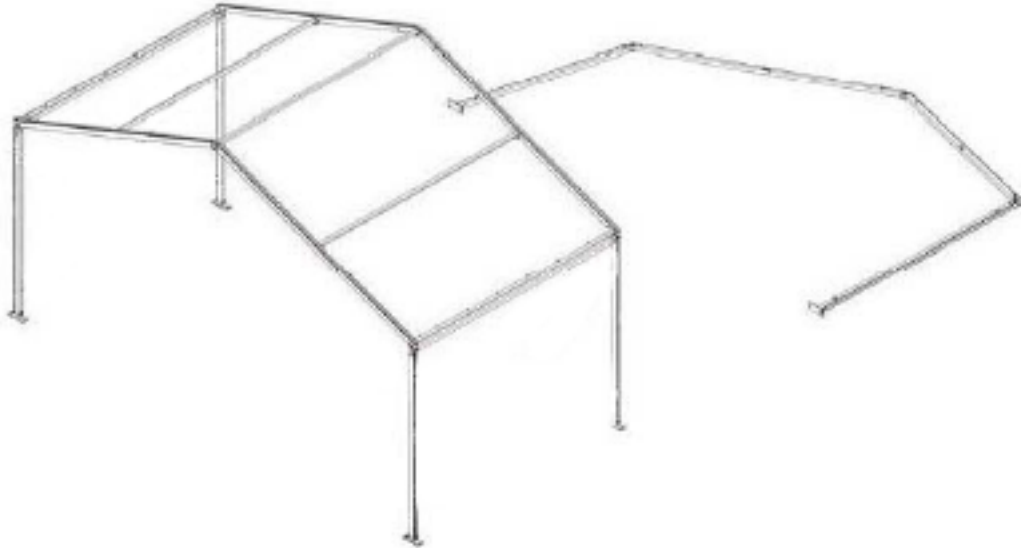

- Erect all frames and put the purlins on the roof as the first section. Place the portal beams like shown below opposite each other and on different sections.

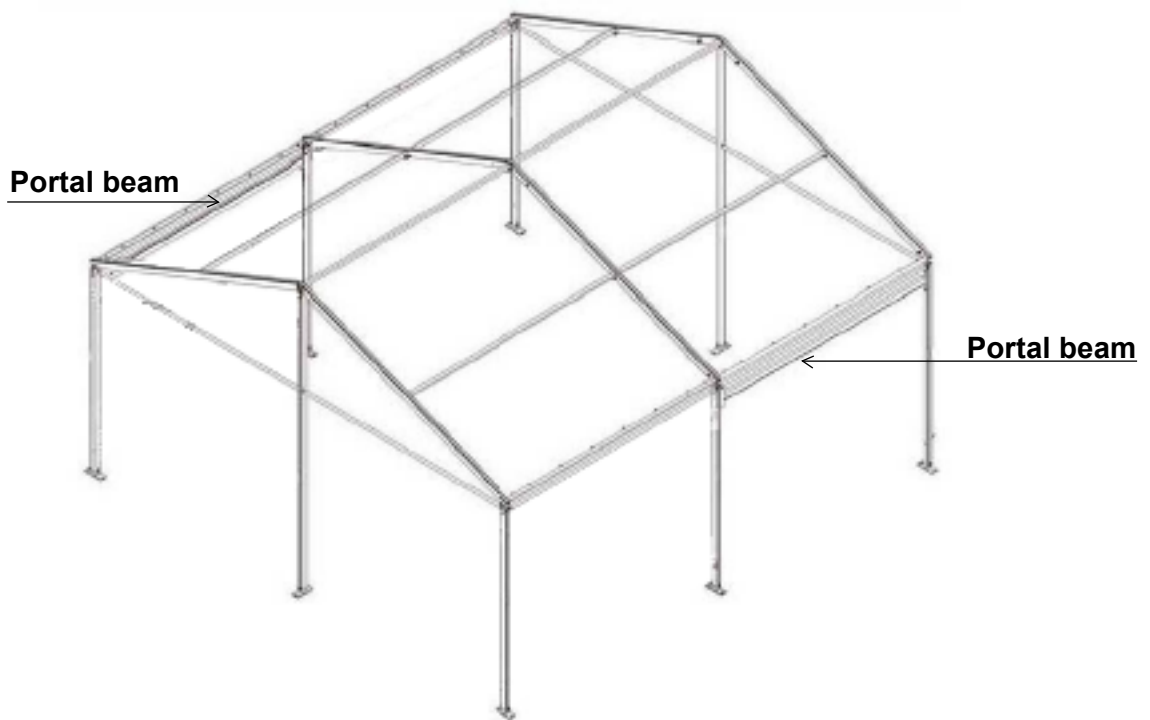

### 3. 'Cover and Sidewalls' Assembling Guide

- **Roof-Cover**

- Unpack the Roof-Cover and put it onto a protecting foil or carpet to avoid it getting dirty or damaged
- Throw 2 PCS of Setup-Ropes over the first unit of the tent
- Tie the Setup-Ropes with the buckles inside of the Roof-Cover
- Lift the Roof-Cover up to the eaves and insert the Keder into the groves of the Roof-Beams
- Slowly pull in the Roof-Cover with equal force on both sides
- Pull in until the Roof-Cover reaches the opposite eaves
- Repeat the procedure until all Roof-Covers have been pulled on

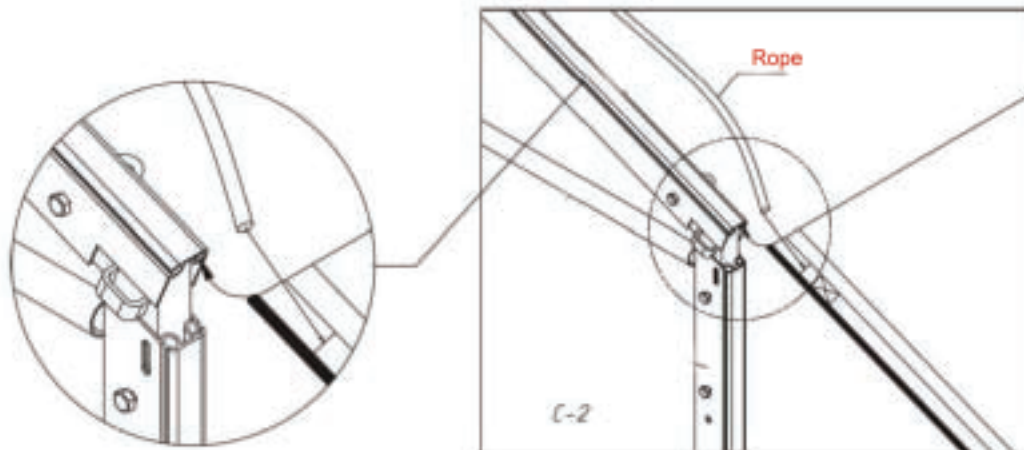
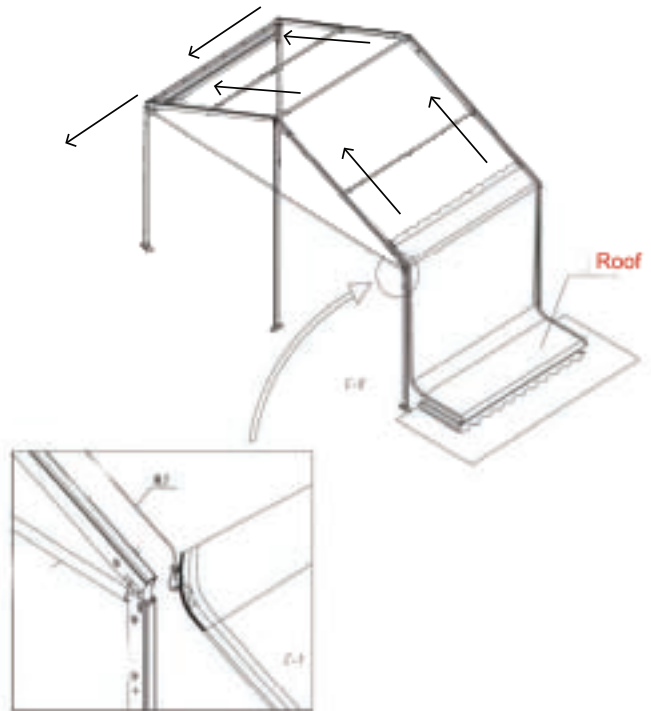

**Caution:**

The Roof-Cover has to be completely inserted into the groove of the Roof-Beam.

- **Tensioning of the Roof-Cover**

After all Roof-Covers have been pulled in, tighten the white Tension-Straps, starting in the middle of the Eave-Beam.



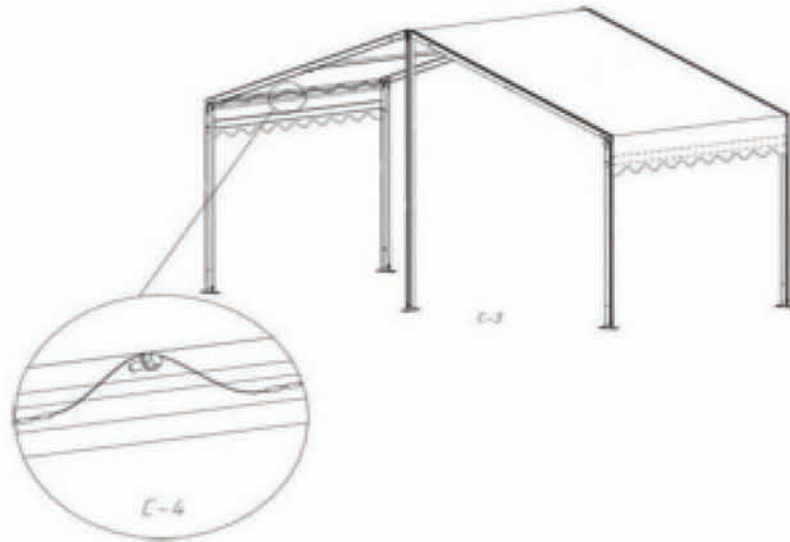

● **Gable Triangle**

- Divide the Gable-Cover into two pieces
- Insert each triangle into the Roof-Beam, starting from the Upright-Support
- Connect the two triangles with the zipper

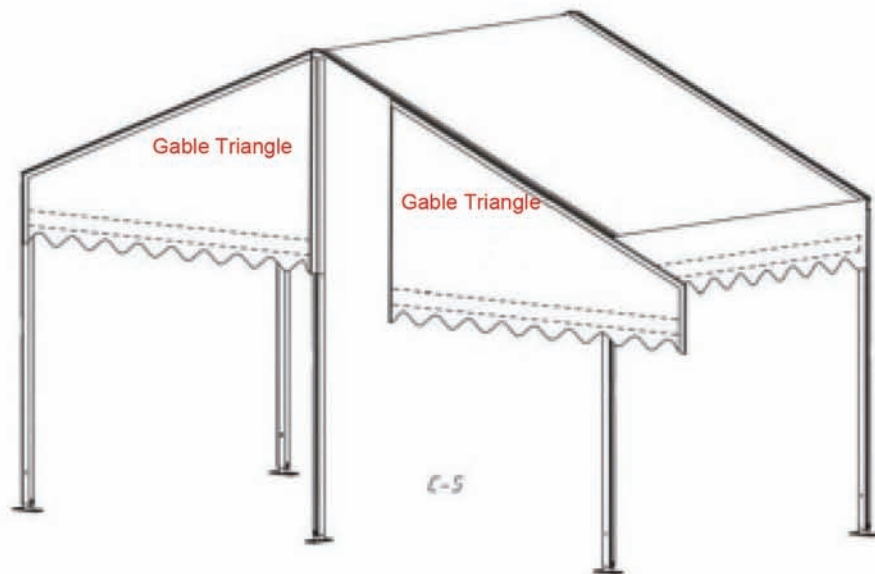

● **Side- and Gable-Walls (Upper Part)**

- Put down the walls in front of the A-Frame-Unit or the Gable-Unit.
- Keep the zipper closed
- Pull the Wall-Tube through the rings of the curtain
- Open the rope
- Insert the Keder of the walls

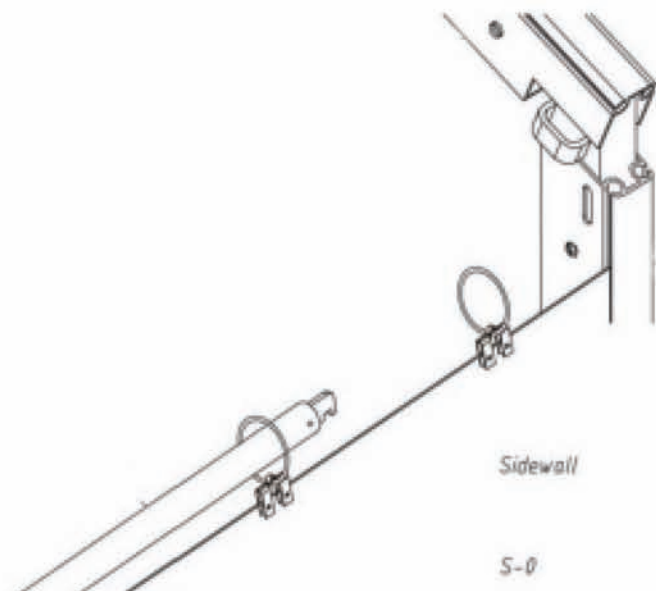

into the groove at the Insertion-Gap in the middle of the Upright-Support



- Pull up the wall in a synchronized movement (left and right side) until reaching the eaves
- Insert the hook of the Wall-Tube as deep as possible into the slot at the Upright-Support
- Then hang in the hook at the opposite side

● **Side- and Gable-Walls (Lower Part)**

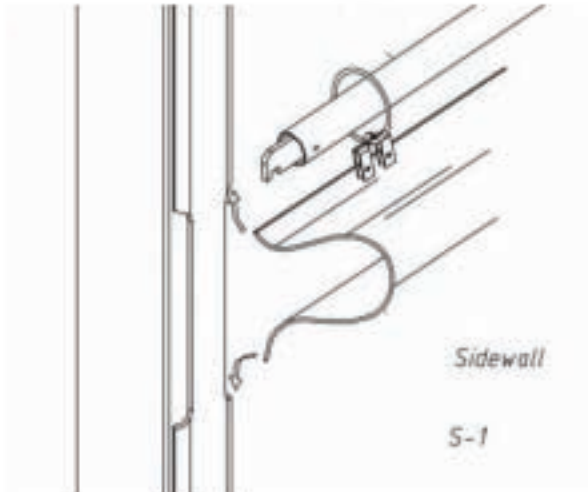

- Insert the Keder of the lower part of the walls into the gap at the groove of the Upright-Support
- Pull downwards with equal force on both sides
- After all walls have been inserted, close all zippers











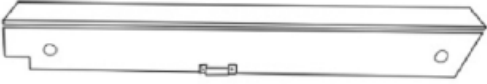

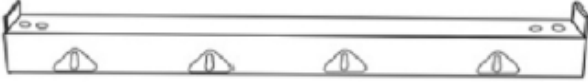
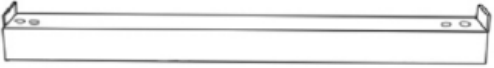
● **Bolt**

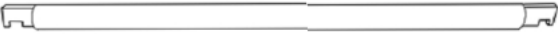
- 10x60mm:    
To connect above 2 Parts;

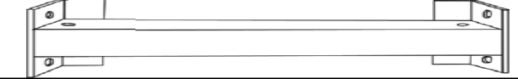
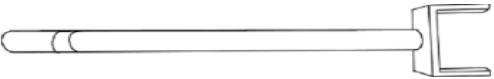
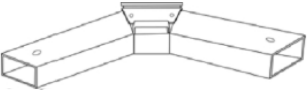
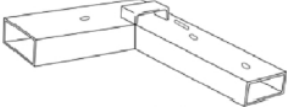
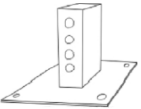
- 10x80mm:   
To fix above Part;

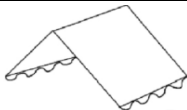
- 10x110mm:    
To connect above Parts;

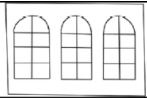
Part no.	Part		6x6 m	6x9 m	6x12 m	6x15 m
	Description	Drawing	pcs	pcs	pcs	pcs
1	Roof beam		6	8	10	12
2	Leg		6	8	10	12
3	Beam		4	6	8	10
4	Purlin		6	9	12	15
5	Gable pole		2	2	2	2
6	Normal top tube		4	6	8	10
7	Gable top tube		4	4	4	4
8	Bottom tube		8	10	12	14
9	Portal beam		2	2	2	2
10	Steel fork		1	1	1	1
11	Apex		3	4	5	6
12	Knuckle		6	8	10	12
13	Foot plate		8	10	12	14
14	Peg		16	20	24	28
15	Cover		2	3	4	5

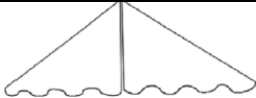
Part no.	Part		6x6 m	6x9 m	6x12 m	6x15 m
	Description	Drawing	pcs	pcs	pcs	pcs
16	Sidewall w. window		4	6	8	10
17	Roll up door wall		2	2	2	2
18	Plain wall		2	2	2	2
19	Gable Wall		2	2	2	2
20	Bolt 10x60mm		18	22	26	30
21	Bolt 10x80mm		8	12	16	20
22	Bolt 10x110mm		8	16	24	32

22-08-2014

---

## 5. Fundamental

- A. Make sure the surface of the aluminum profiles are glabrous and avoid a damage of the protective layer
- B. The stack height of the aluminum profiles can't exceed 80cm. Otherwise, you should put a crosstie every 80cm height
- C. Please do not modify any aluminum, profile or make any gap or groove on them
- D. During the transportation, the crossties should be put among the aluminum profiles. Avoid heavy weight on the aluminum profiles to cause distortion
- E. To avoid mildews, make sure the fabric is 100% dry when folding it
- F. The covers and walls have to be deposited in their packing sacks. Avoid a damage of the fabrics by friction, fire, dye, etc
- G. Avoid glue on the frame or covers, that will affects the appearance of the tent
- H. When install the covers and walls, make sure that you put it into a protecting foil or carpet to avoid it getting dirty or damaged
- I. Don't loosen the bolts freely. Fix the bolts not too strong but solid. Please tighten them by hands and avoid any damages on the aluminum profile
- J. No flame for barbeque or other events in the tents. (If the temperature is over 70 °C, the cover fabric will be distorted)
- K. The frame parts and fabric for Roof, Gable, Cover and Wall should be packed respectively
- L. The tents should be stocked in a dry place
- M. If any fabrics, ropes or frames are damaged, please use the repair kit and spare parts to repair them.

## Contact information

### Head office:

Dancover A/S  
Nordre Strandvej 119 G  
3150 Hellebæk  
Denmark

For more information  
please visit:  
[www.dancovershop.com](http://www.dancovershop.com)

## National contact

Denmark: 70 26 76 20  
[denmark@dancover.com](mailto:denmark@dancover.com)

UK: 020 8099 7570  
[uk@dancover.com](mailto:uk@dancover.com)

Germany: 041 0266 7040  
[germany@dancover.com](mailto:germany@dancover.com)

France: 0975 181 800  
[france@dancover.com](mailto:france@dancover.com)

Sweden: 040 233 262  
[sverige@dancover.com](mailto:sverige@dancover.com)

Finland: 0 931 581 720  
[suomi@dancover.com](mailto:suomi@dancover.com)

Poland: 22 300 8602  
[polska@dancover.com](mailto:polska@dancover.com)

Luxembourg: +49 041 0266 7040  
[luxembourg@dancover.com](mailto:luxembourg@dancover.com)

Portugal: 308 800 899  
[portugal@dancover.com](mailto:portugal@dancover.com)

Spain: 911 436 828  
[espana@dancover.com](mailto:espana@dancover.com)

Italy: 02 479 21 198  
[italia@dancover.com](mailto:italia@dancover.com)

Switzerland: 0840 000125  
[schweiz@dancover.com](mailto:schweiz@dancover.com)

Austria: 0662 626935  
[austria@dancover.com](mailto:austria@dancover.com)

Norway: 231 00 690  
[norge@dancover.com](mailto:norge@dancover.com)

Nederland: 0 858 880 524  
[nederland@dancover.com](mailto:nederland@dancover.com)

Ireland: 0 151 33 003  
[ireland@dancover.com](mailto:ireland@dancover.com)

Belgium: 0 28 08 08 09  
[belgique@dancover.com](mailto:belgique@dancover.com)