

DANCOVER[®]

.com

Manual
for
Pole Tent
Semi PRO 4x8m

DANCOVER[®]

.com

Safety Advice

Attention

In some countries approval is needed to set up a marquee/tent larger than 75 m². It is your responsibility to comply with local rules and regulations and to ensure that the marquee/tent is assembled correctly.

In case of bad weather conditions, it is your responsibility to ensure the marquee/tent is safely secured and that the marquee/tent does not cause damage to others.

Do not use open fire, welding equipment or other sources which can ignite, inside or close to the tent.

The marquee/tent must be safely secured. We recommend you secure your marquee/tent with straps and pegs as soon as it is assembled.

Make sure to check if the marquee/tent is covered by your home contents insurance.

Marquees/tents must be evacuated under extreme weather conditions.

In the event of snow, always remove snow from the roof of the marquee/tent regularly to prevent snow from building on the roof, as heavy snow can cause the marquee/tent to collapse.

In the event of rain, there is a risk of rain puddles building up on top of the roof of the marquee/tent. Heavy rain puddles can cause the roof to collapse. It is your responsibility to ensure rain puddles do not build up. As a precaution, make sure the roof of the marquee/tent is stretched out properly and adequately over the side frames of the marquee/tent and remove rain water regularly.

Do not unpack or repack your marquee/tent in freezing temperatures. In case of temperatures below zero, always unpack and repack your marquee/tent indoors to avoid the risk of cracking parts.

The marquee/tent must be totally dry before you repack and store it to avoid mildew.







Note: Marquees are intended for events and other arrangements and are as such only meant for short term temporary assembly and the following disassembly. Dancover warranty applies only to the normal use of the Product, normal wear and tear excepted, in accordance with written use instructions or manual. The warranty does not apply to damage caused by accident, abuse, misuse, or modification of the Product.

Warranty Information

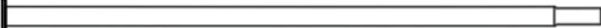
Please visit dancovershop.com for information on warranty.

Please always check our website for the latest safety advice and manual.

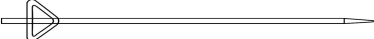
Part List For 4x8m Pole Tent

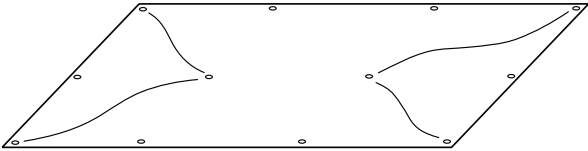
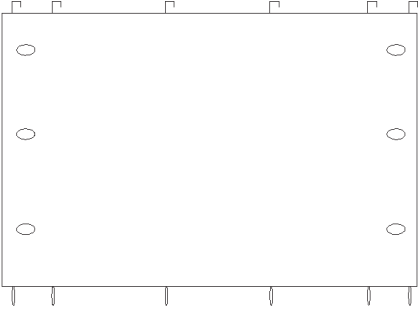
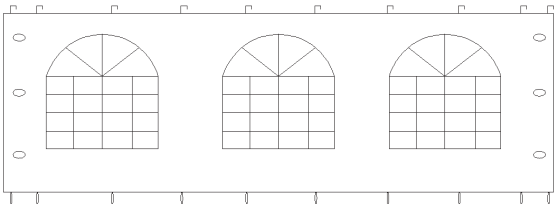
Description	Item No.	QTY	Picture
Side Pole	A	10	
Side Pole	B	10	
Center Pole	C	2	
Center Pole	D	2	
Center Pole	E	2	
Anchor		14	
Adjustable Rope		14	
Roof		1	
Sidewall 4m		2	
Sidewall 8m		2	

Installation:

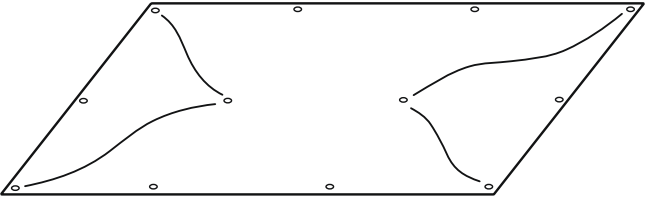

STEP 1

Unroll and unfold the tent top on the desired sport to be covered. Keep the tent top as square as possible. Pull the perimeter of the tent as tight as possible, the center of the tent top will not be tight or lay flat due to the peak of the tent.

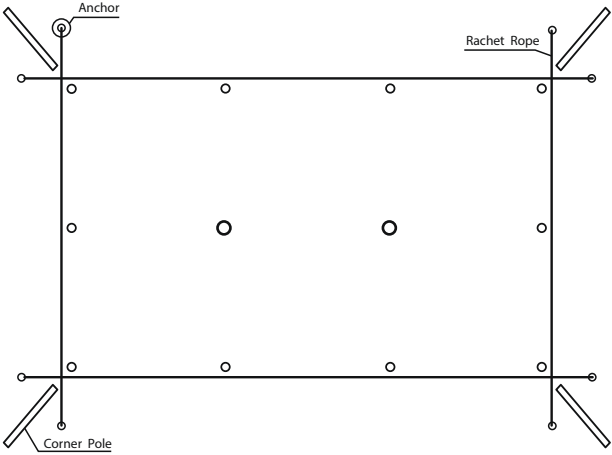

STEP 2

Layout all the hard ware around the tent as show, placed anchors approximately 4' from the grommet locations. 1 pole to each grommet location. Connect the 4 piece center pole together.

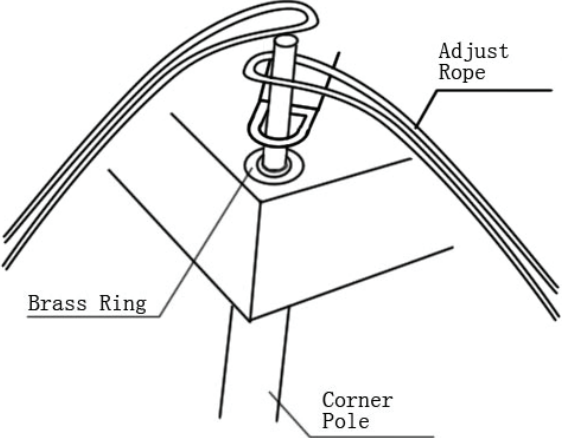

STEP 3

Insert the corner pole pin through "D" ring, and brass grommet. Set two pieces of adjust rope on the pole pin.

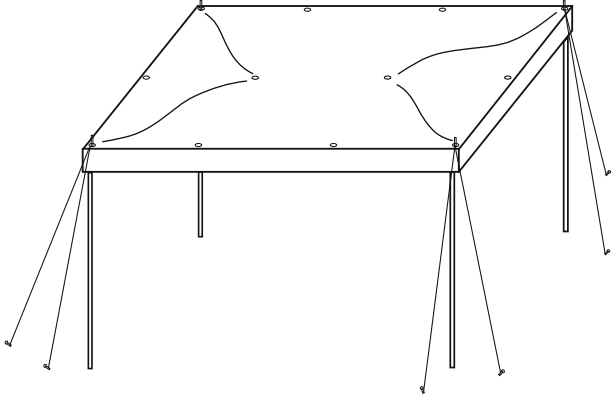

STEP 4

Set the corner pole leaning in towards the tent at 90 angle. Repeat all 4 corners. And tie the rope on the anchors. Adjust the handle to strength the rope to make all poles stable.

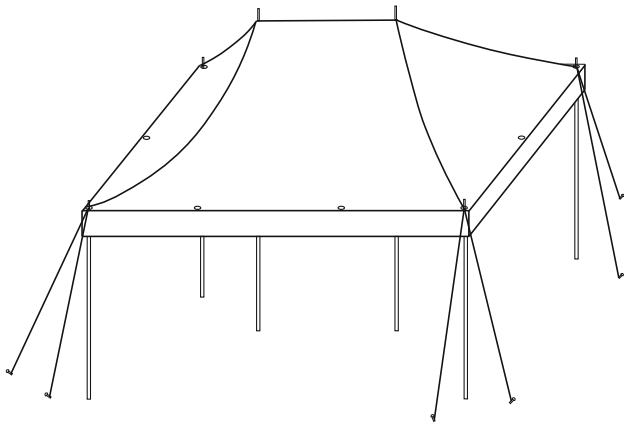

STEP 5

Insert the center pole tip through the center "D" ring and brass grommet, make sure that the pin is not caught on any part of the tent top. Push the center pole into a vertical position.

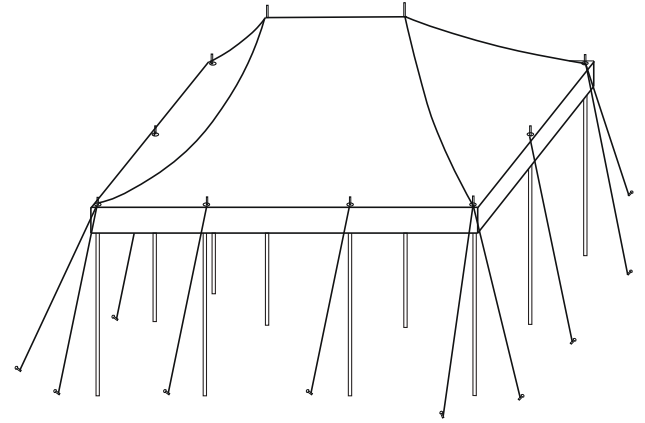

STEP 6

With the corner poles and center pole vertically straight. We will add the remaining side poles. Insert the pole pins at each location, through the "D" ring and brass grommet and cover with one adjust rope for each pole. Put the pole at straight vertical position. Tie the ropes on the anchors.

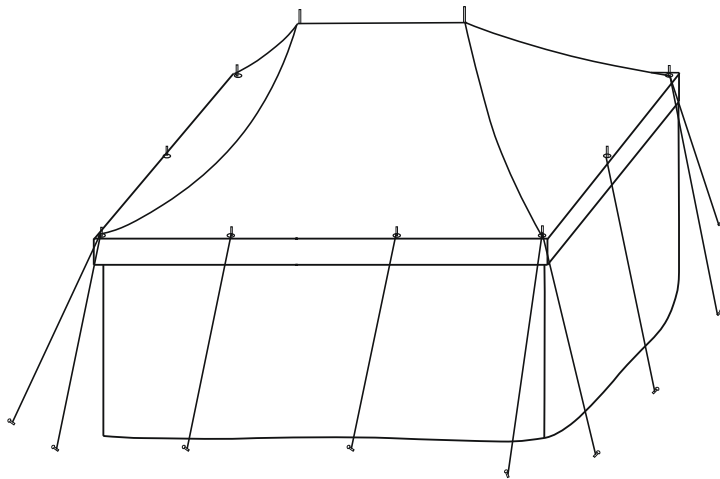

STEP 7

Mount all four sidewalls to finish the tent assembly.

Warning !!!

1. The tent is designed for party or wedding , no use for storage.
2. It is necessary to take the tent down in case of bad weather.
3. We can not be held for responsible in case of bad use, improper set up or damage by bad weather.

DANCOVER[®]

.com

Contact information

Head office:

Dancover A/S
Nordre Strandvej 119 G
3150 Hellebæk
Denmark

For more information
please visit:

www.dancovershop.com

National contact

Denmark: 70 26 76 20
denmark@dancover.com

UK: 020 8099 7570
uk@dancover.com

Germany: 041 0266 7040
germany@dancover.com

France: 0975 181 800
france@dancover.com

Sweden: 040 233 262
sverige@dancover.com

Finland: 0 931 581 720
suomi@dancover.com

Poland: 22 300 8602
polska@dancover.com

Luxembourg: +49 041 0266 7040
luxembourg@dancover.com

Portugal: 308 800 899
portugal@dancover.com

Spain: 911 436 828
espana@dancover.com

Italy: 02 479 21 198
italia@dancover.com

Switzerland: 0840 000125
schweiz@dancover.com

Austria: 0662 626935
austria@dancover.com

Norway: 231 00 690
norge@dancover.com

Nederland: 0 858 880 524
nederland@dancover.com

Ireland: 0 151 33 003
ireland@dancover.com

Belgium: 0 28 08 08 09
belgique@dancover.com