

MODULARO™

WOODEN GAZEBO BRITTANY

2.4 x 2.4 x 2.41 m



GROUNDPLAN - GRUNDPLAN - PLAN DE MASSE

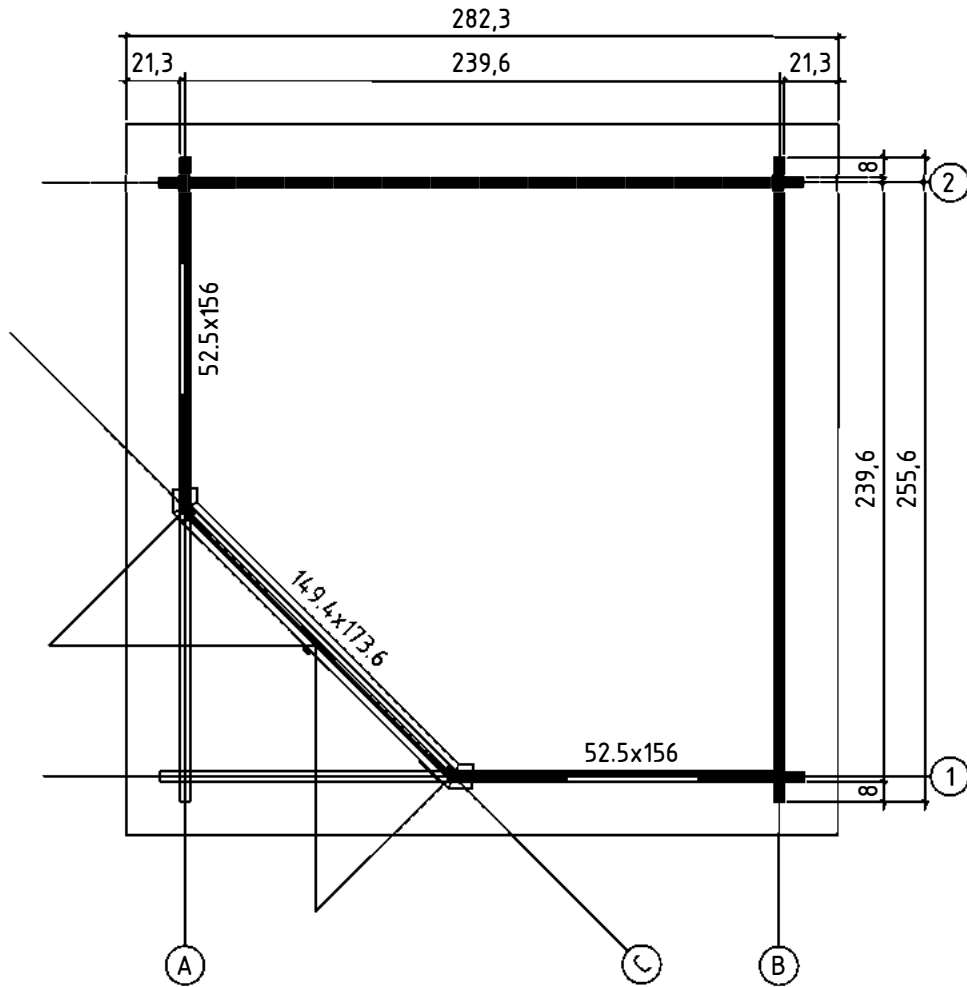

FOUNDATION - FUNDAMENT - FONDATION

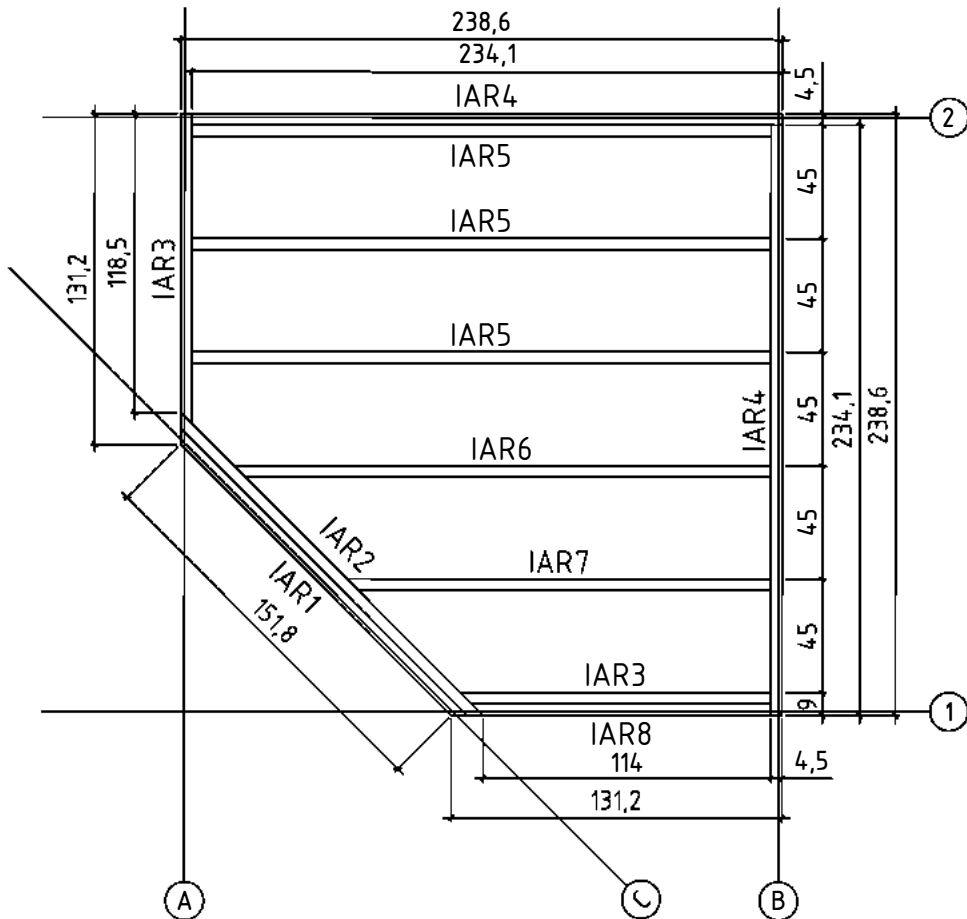

Art.Nr. PA165030

FLOOR BOARDS - FUSSBODENBRETTER - PLAN POSE PLANCHER

Mounting direction - Aufbauschriffe - Instruction de montage

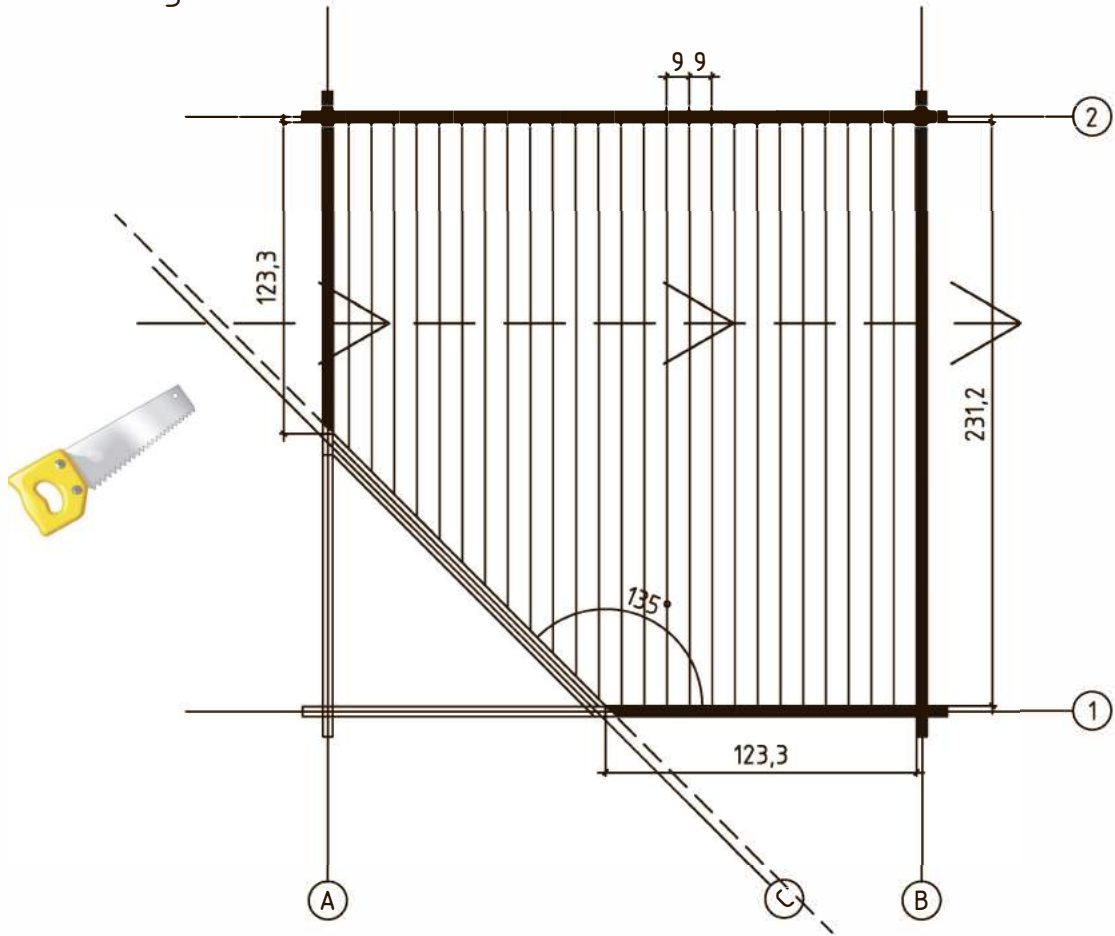

OVERHEAD BEAMS - DECKENBALKEN - SOLIVES

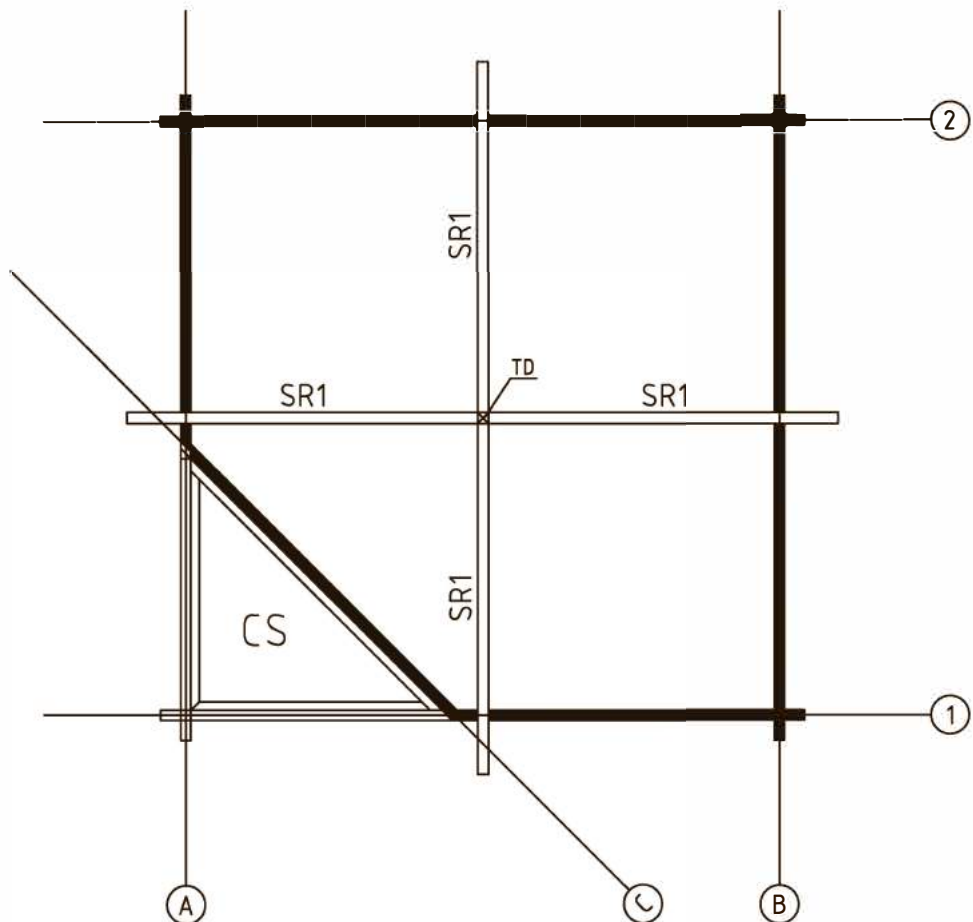

Diagonal must be equal A=B - Prüfung diagonale Austrichtug A=B -
 - Controle des diagonales A=B

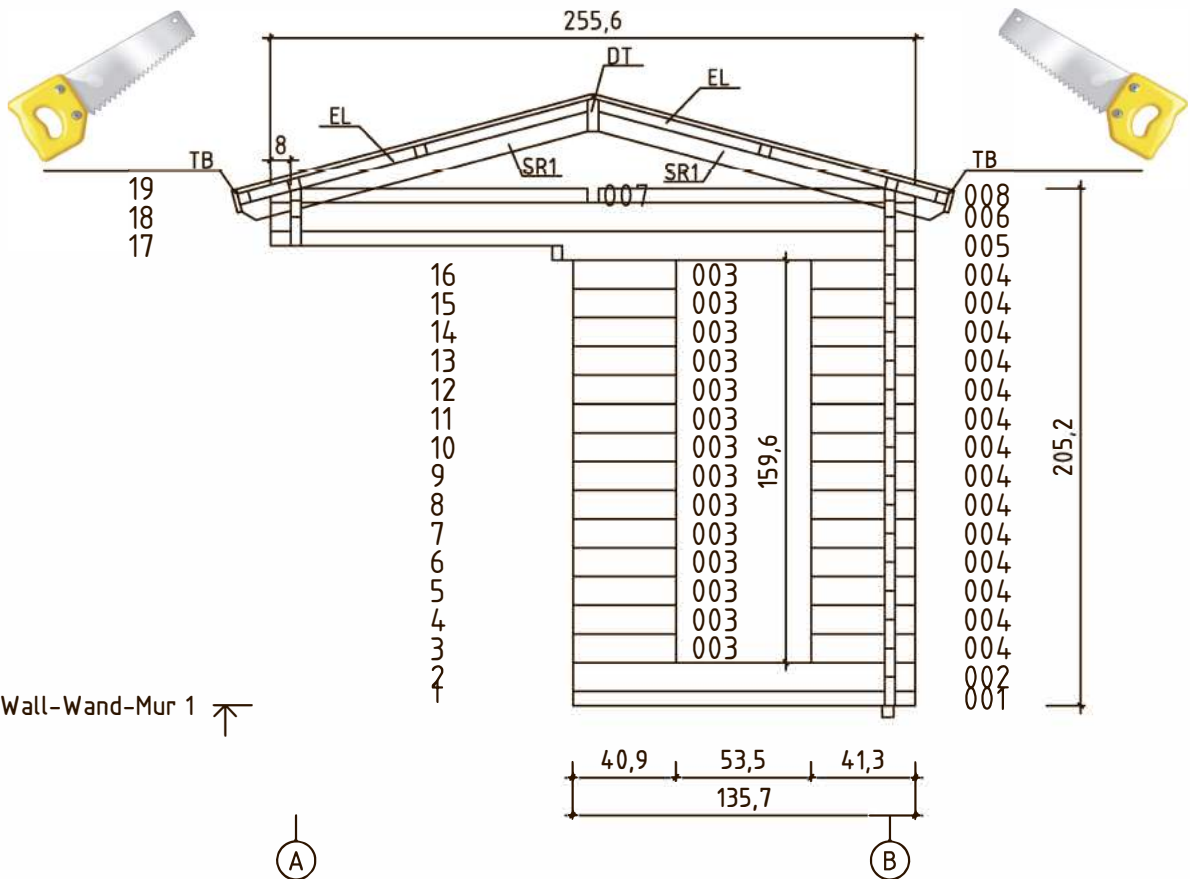
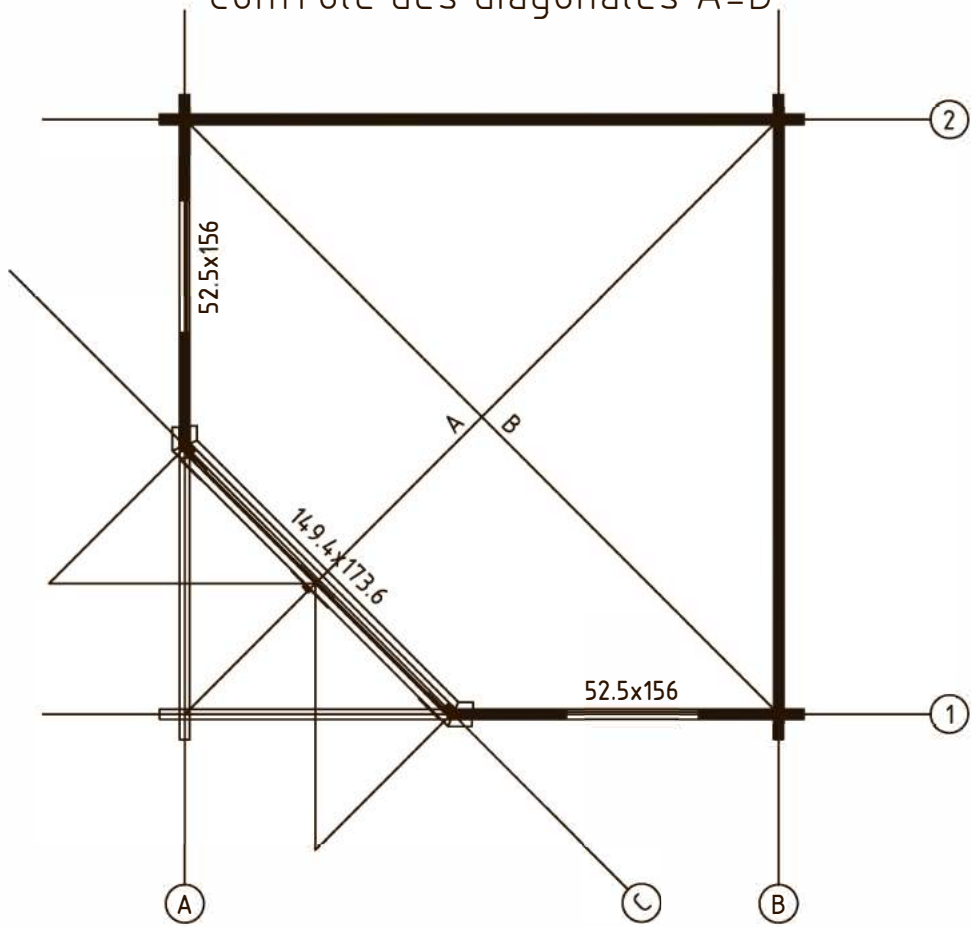

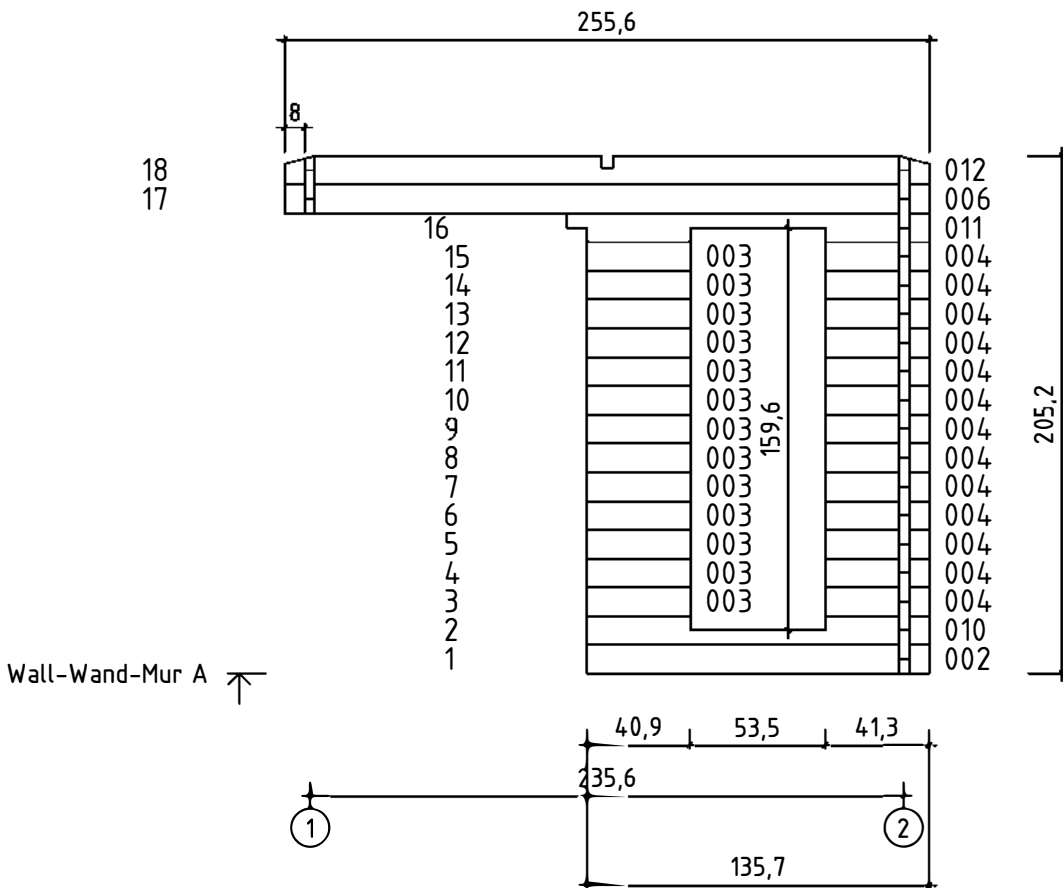
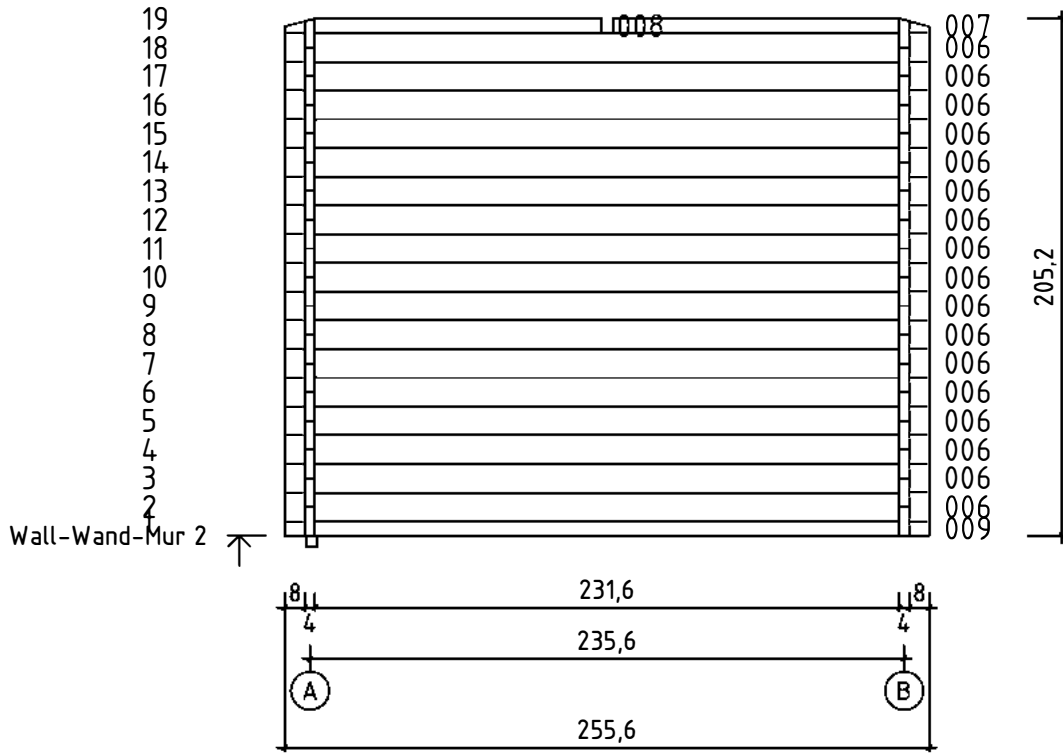

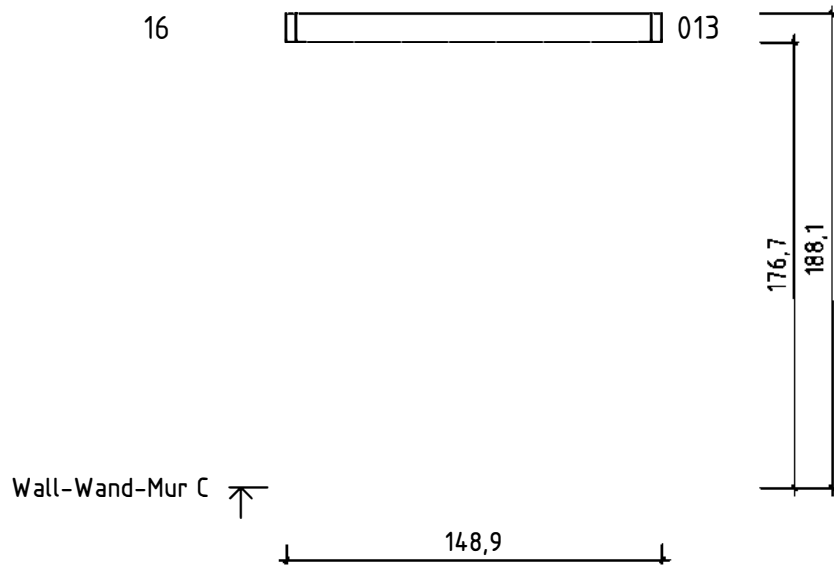
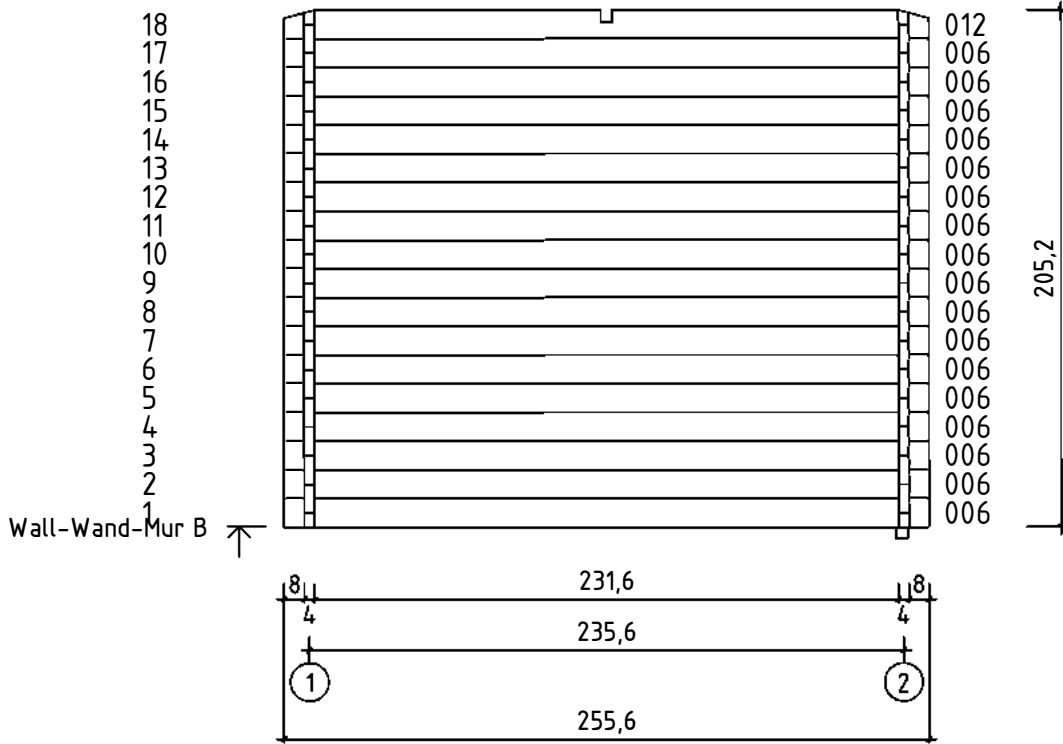

Art.Nr. PA165030

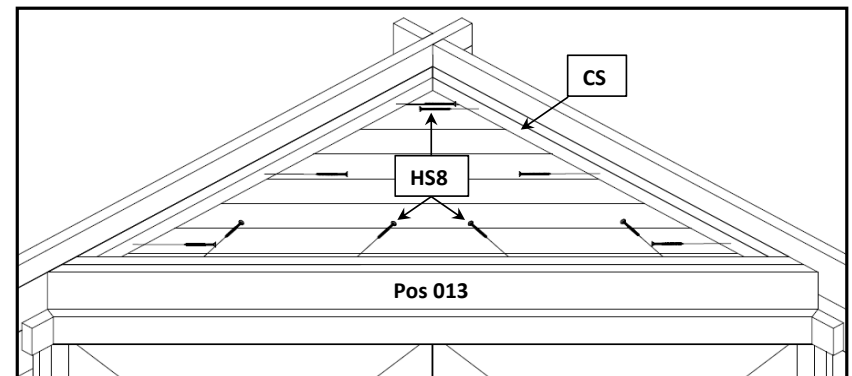
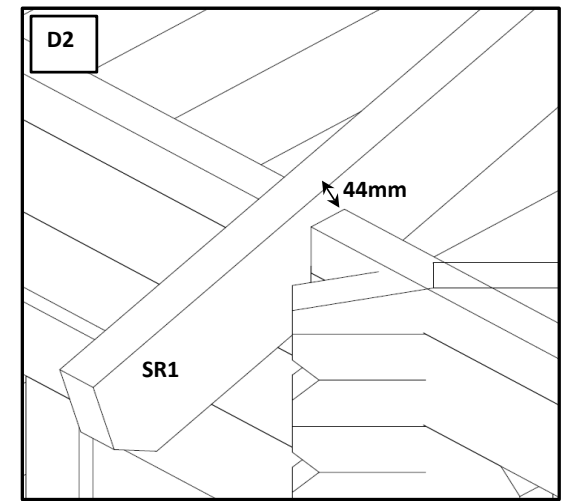
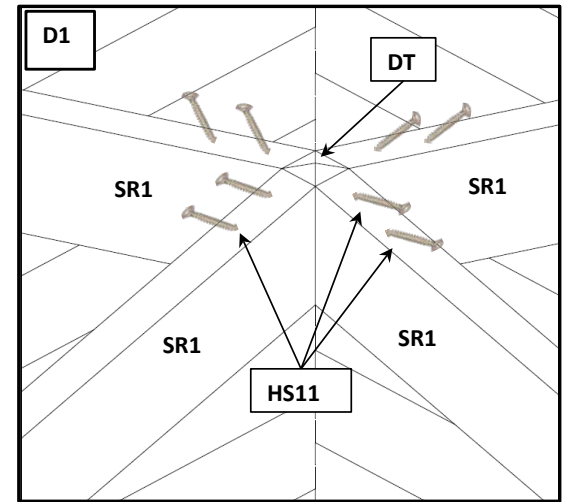
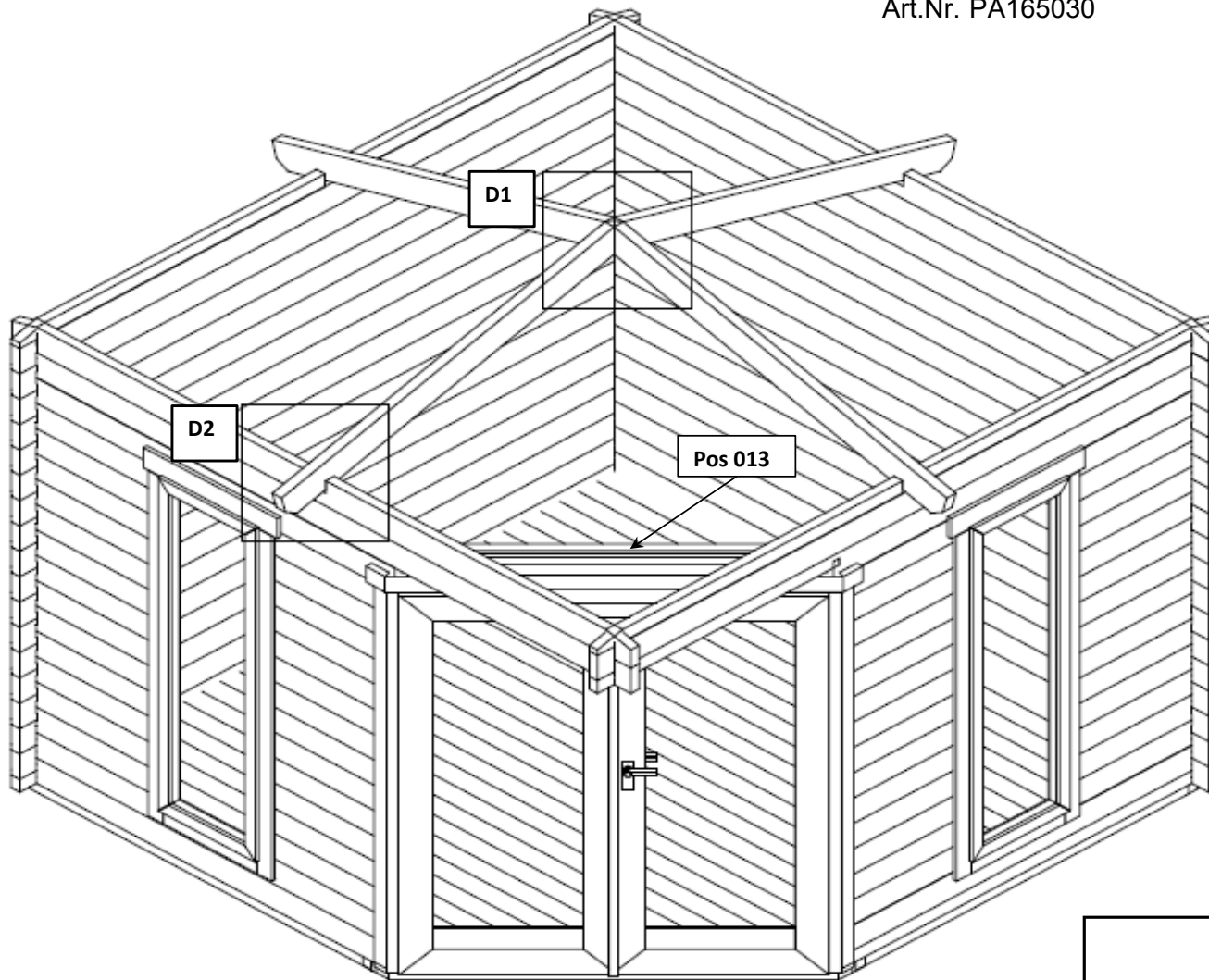

Art.Nr. PA165030

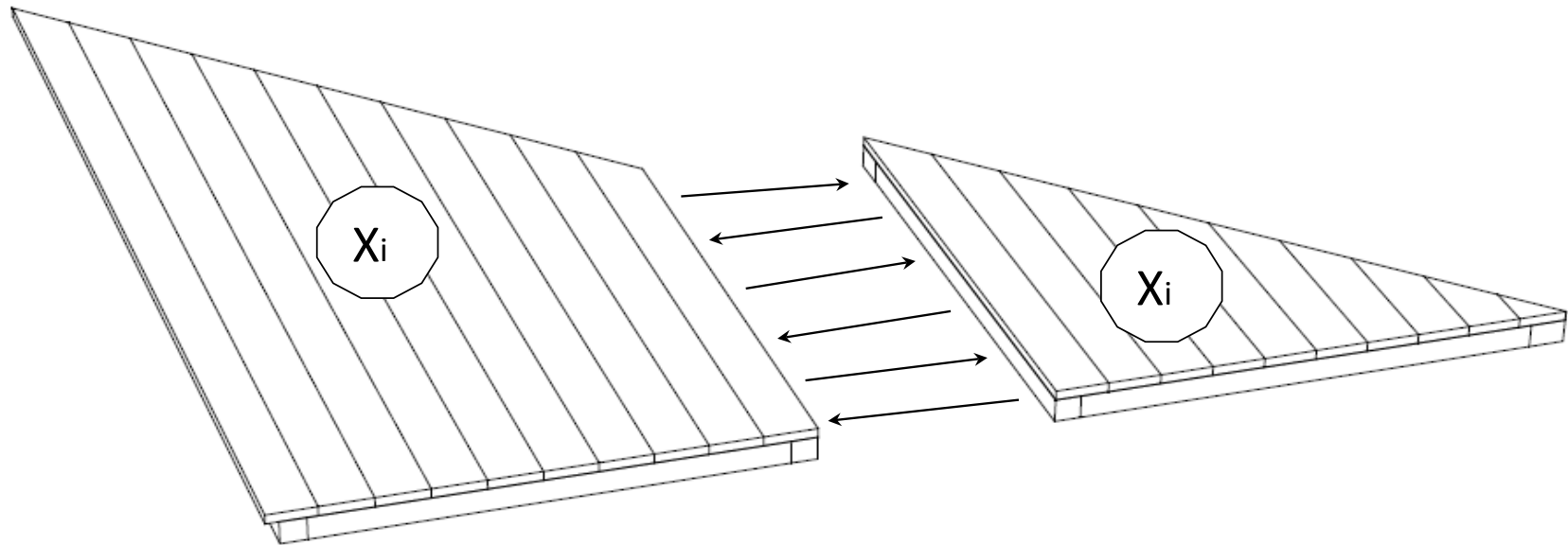

FROM BELOW - VUE DE DESSOUS - ANSICHT VON UNTEN
FROM BELOW - VUE DE DESSOUS - ANSICHT VON UNTEN

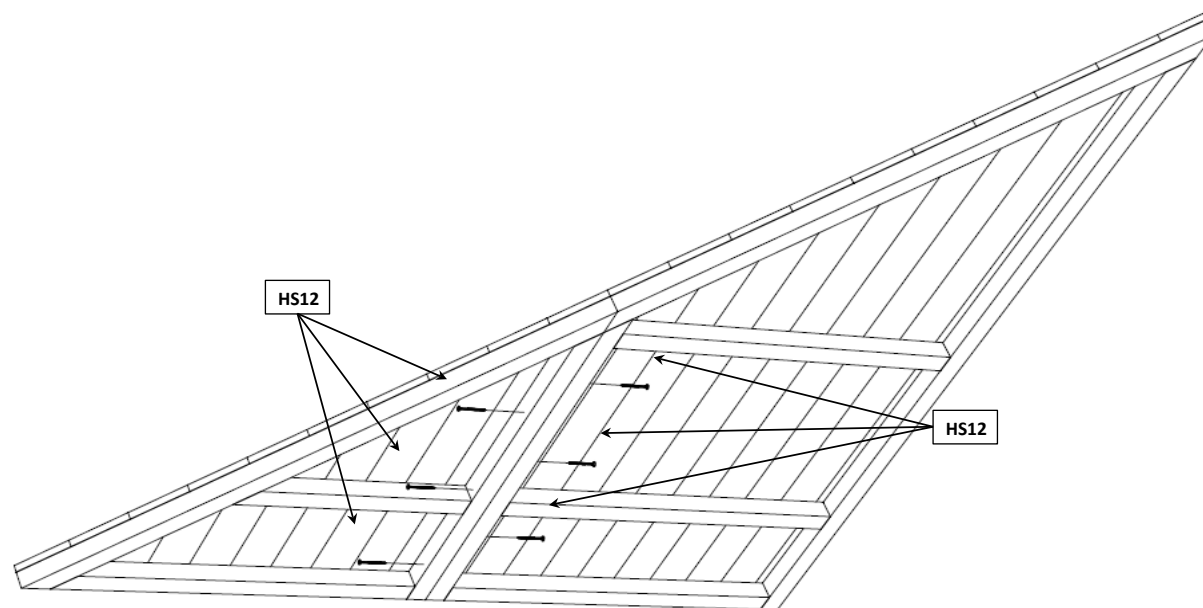

Art.Nr. PA165030

FROM BELOW - VUE DE DESSOUS - ANSICHT VON UNTEN

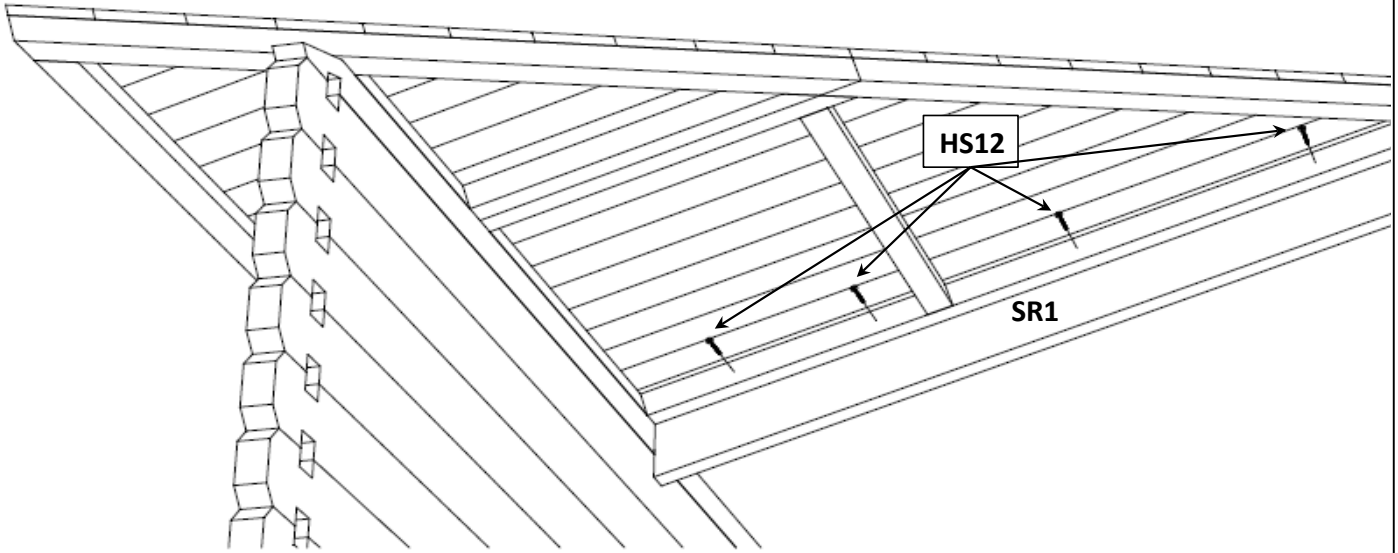



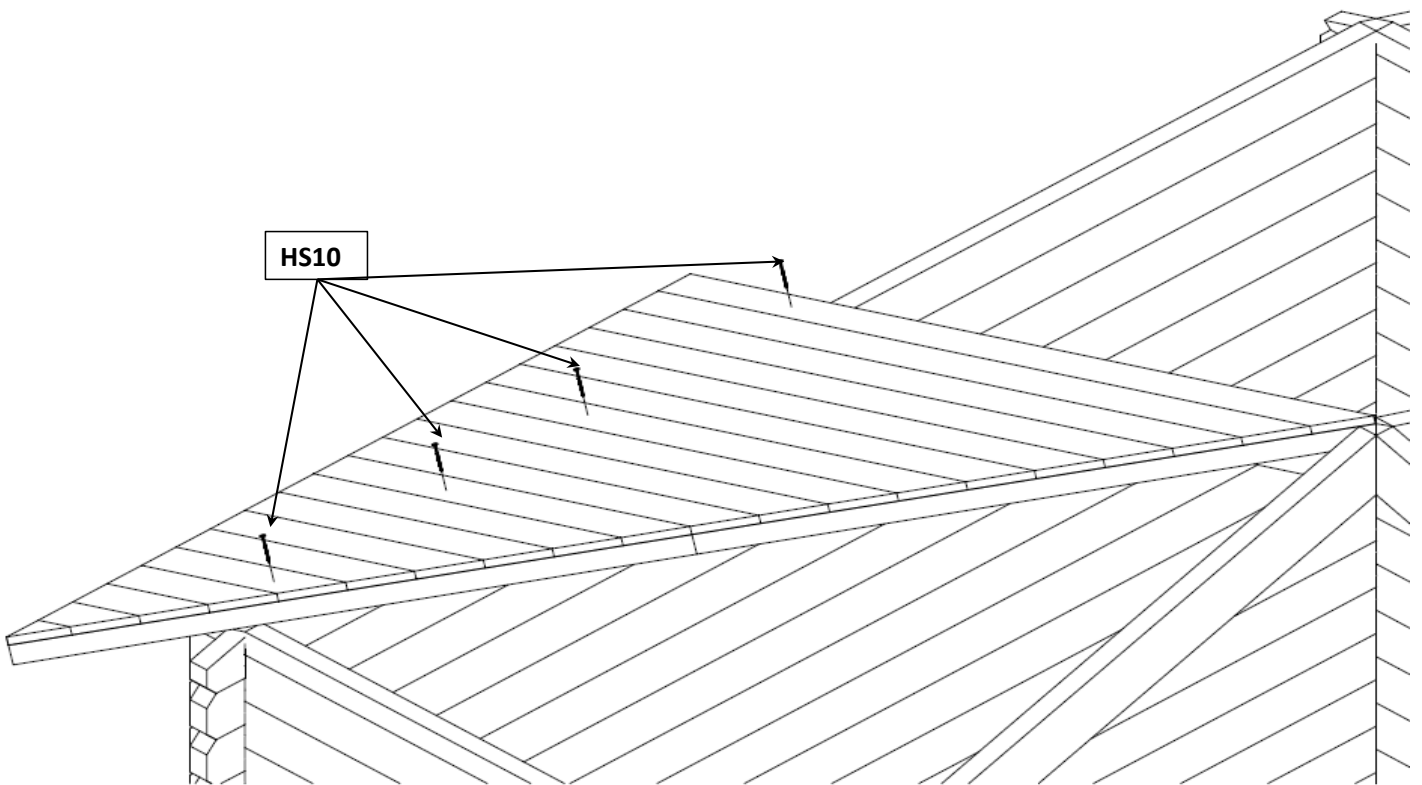



TOP VIEW - ANSICHT VON OBEH - VUE DE DESSUS

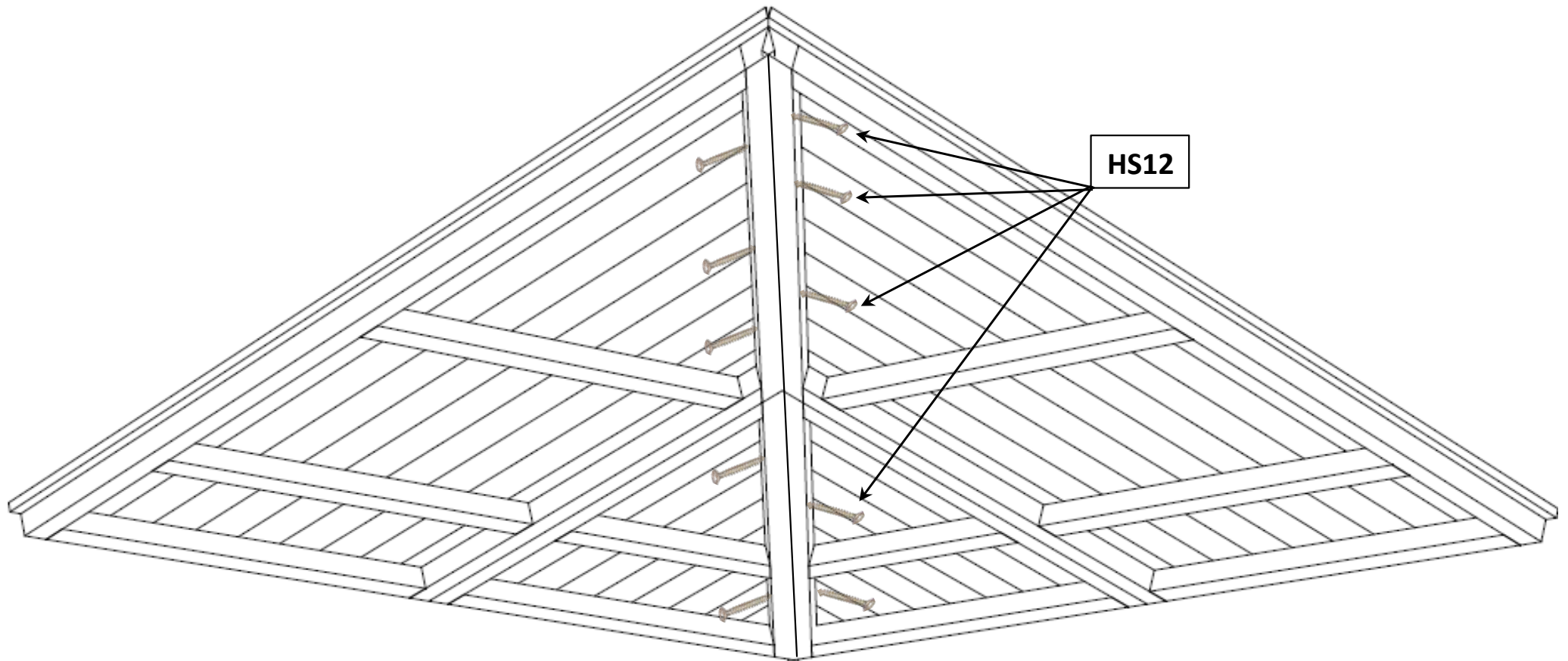

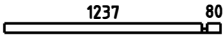
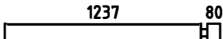

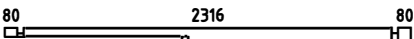
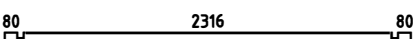

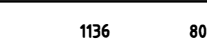
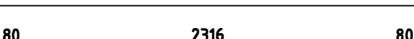
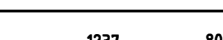
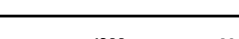
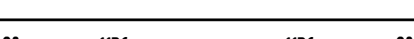
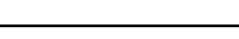

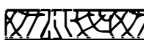

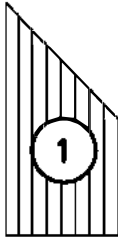
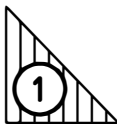
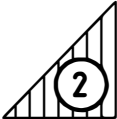
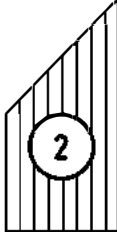
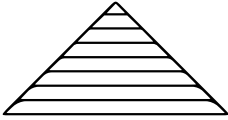

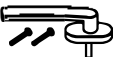

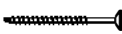

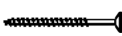
Art.Nr. PA165030

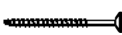
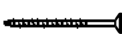

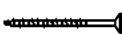

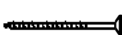

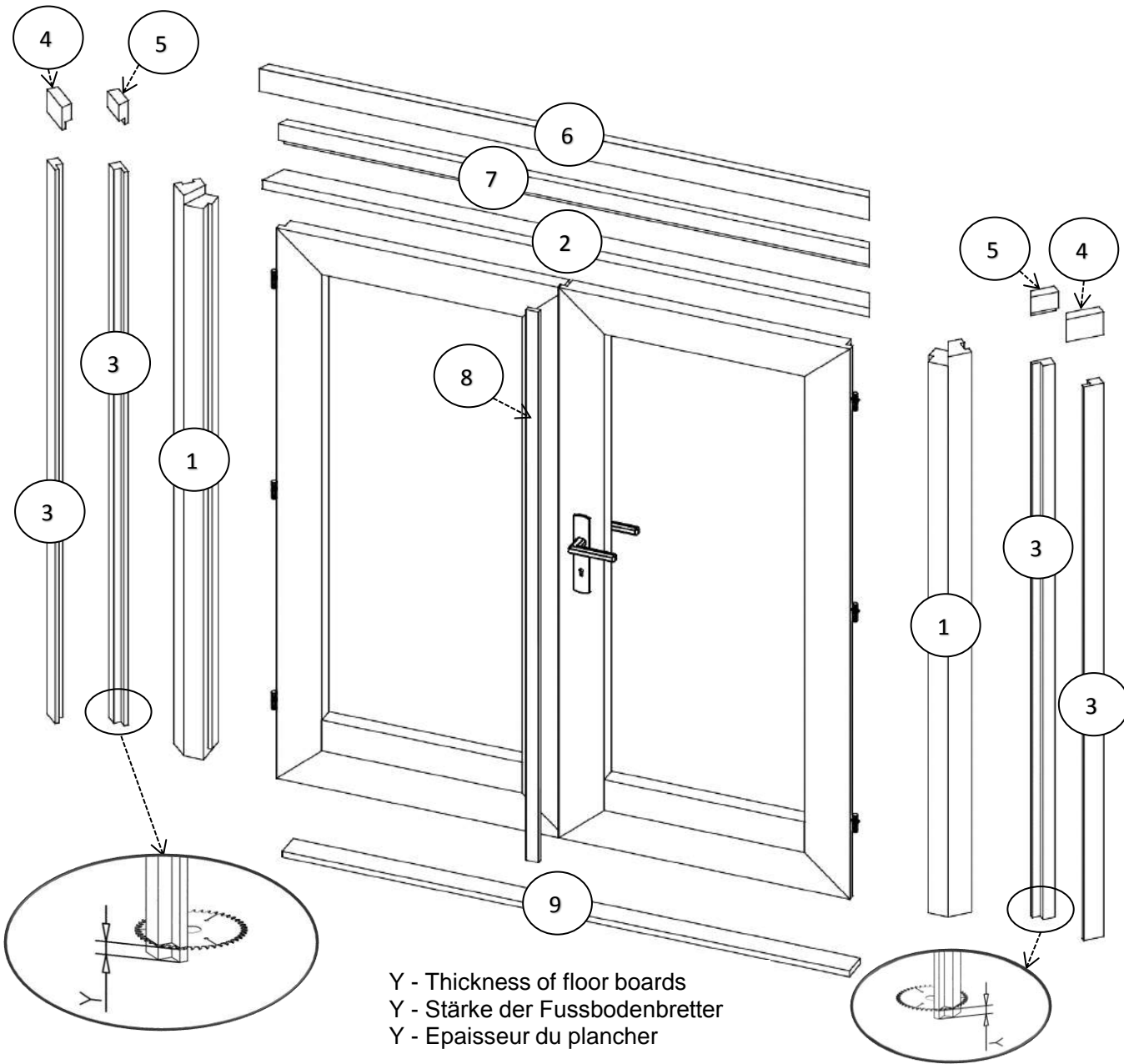

FROM BELOW - VUE DE DESSOUS - ANSICHT VON UNTEN

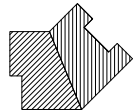

Pos	02.12.2016	Piecelist - Stücklist - Liste des composants Art. Nr. PA165030	11/13	Q.	P. (mm)	L. (mm)
001				1	40x57	1357
002				2	40x114	1357
003				27	40x114	409
004				27	40x114	413
005				1	40x114	2556
006				36	40x114	2556
007				2	40x57	1256
008				2	40x57	1256
009				1	40x57	2556
010				1	40x114	1357
011				1	40x114	1439
012				2	40x114	2556
013				1	40x114	1489
IAR4	FOUNDATION - FUNDAMENT - FONDATION			2	45x45	2341
IAR5	FOUNDATION - FUNDAMENT - FONDATION			3	45x45	2296
IAR6	FOUNDATION - FUNDAMENT - FONDATION			1	45x45	2130
IAR2	FOUNDATION - FUNDAMENT - FONDATION			1	45x45	1698
IAR7	FOUNDATION - FUNDAMENT - FONDATION			1	45x45	1680
IAR1	FOUNDATION - FUNDAMENT - FONDATION			1	45x45	1608
IAR3	FOUNDATION - FUNDAMENT - FONDATION			2	45x45	1230
IAR8	FOUNDATION - FUNDAMENT - FONDATION			1	45x45	1185
SR1	RAFTER - DACHSPARREN - CHEVRON			4	44x120	1438
	FLOOR BOARDS - FUSSBODENBRETTER - LAME DE PLANCHER			26	90x18	2312
	FLOOR FILLET-FUSSBODENLEISTE - CORNIERE DE FINITION DU PLANCHER				18x18	9.25
TB	EAVES BOARD - TRAUFBRETT - BANDEAU DE TOIT			4	18x90	3000

Pos	02.12.2016	Piecelist - Stücklist - Liste des composants Art. Nr. PA165030	12/13	Q.	P. (mm)	L. (mm)
EL	ROOF SHIELD - ELEMENT - PANNEAU DE TOITURE			4	1461x1411	
EL	ROOF SHIELD - ELEMENT - PANNEAU DE TOITURE			4	1461x1411	
CS	CEILING SHIELD - ELEMENT - PANNEAU DE TOITURE			1	1409x705	
	STORM PROTECTION - STURMLEISTE - LATTE ANTI-TEMPETE			5	22x45	2050
DT	ROOF SUPPORT - DACH TRÄGER - SUPPORT DE TOIT			1	44x44	130
	WINDOW HANDLE FITTINGS - FENSTERGRIFF - POIGNÉE D'OUVERTURE DE FENETRE			2		
HS8	SCREW FOR TRIANGULAR FIXING - MONTAGENSCHRAUBE FÜR DREIECKIGE - - VIS D'ASSEMBLAGE POUR TRIANGLE			10	4x60	
	SCREW FOR 1. WALL BEAM - SCHRAUBE FÜR 1. BOHLENREIHE - VIS DE FIXATION DES FONDATIONS			4	5x90	
HS3	SCREW FOR DOOR FILLET - SCHRAUBE ZUR BEFESTIGUNG TÜRLEISTE - VIS D'ASSEMBLAGE DU CADRE DE PORTE			5	3x30	
HS22	SCREW FOR FIXING DOOR TO THE WALL - SCHRAUBE ZUR BEFESTIGUNG TUR - ZARGE MIT WAND - VIS POUR FIXATION DORMANT DE PORTE AU 1ER RANG DE MADRIER			2	3.5x50	
HS45	SCREW FOR COVERING MOULDING - SCHRAUBEN FÜR DECKUNGSPROFIL - VIS DE FIXATION PROFILS DE FINITION VERTICAUX A FIXER A L'EXTERIEUR DU CADRE DE LA PORTE			26	4x40	
	SCREW FOR EAVES BOARDS - SCHRAUBEN FÜR TRAUFBRETTEN - VIS DE FIXATION POUR BANDEAU DE TOIT			28	4x40	
	SCREW FOR POS 013 - SCHRAUBEN FÜR POS 013 - - VIS POUR POS 013			4	4x60	
HS10	SCREW FOR SHIELD - SCHRAUBEN ZUR ELEMENT VIS POUR DE PANNEAU DE TOITURE			48	5x120	
HS11	SCREW FOR RAFTER - SCHRAUBEN FÜR DACHSPARREN - - SCHRAUBEN FÜR DACHSPARREN - VIS POUR CHEVRON			12	5x120	
	SCREW FOR FUNDAMENT - SCHRAUBEN ZUR BEFESTIGUNG FUNDAMENT - VIS POUR FONDATION			23	5x90	
	SCREW FOR POS 005 - SCHRAUBEN FÜR POS 005 - - VIS POUR POS 005			2	5x90	
HS41	SCREW FOR DOOR JAMB - SCHRAUBE FÜR TÜRRAHMEN - VIS DE FIXATION POUR MONTANT DE PORTE			4	5x90	
HS12	SCREW FOR SHIELD - SCHRAUBEN ZUR ELEMENT VIS POUR DE PANNEAU DE TOITURE			120	6x80	
HC	COVERS FOR DOOR HINGES - SCHUTZKAPPE FÜR TÜRBAND - COUVERTURE DE PAUMELLE DE PORTE			12		



Pos	Piece list - Stückliste - Liste des pièces	Q.	P (mm)	L (mm)
1		2	77x60	1736
2		1	77x38	1538
3		4	28x50	1721
4		2	28x70	94
5		2	28x70	66
6		1	28x70	1546
7		1	28x70	1489
8		1	13x32	1706
9		1	18x77	1438

