

Manual  
for  
Base for  
ProShed  
3,4x3,82x2,05m



# Floor Frame Kit

Bodenrahmen-Bausatz \* Kit de cadre pour plancher \* Kit de entramado de pisos

# Assembly Manual

Montagehandbuch \* Manual de ensamblaje

\* Guide d'assemblage

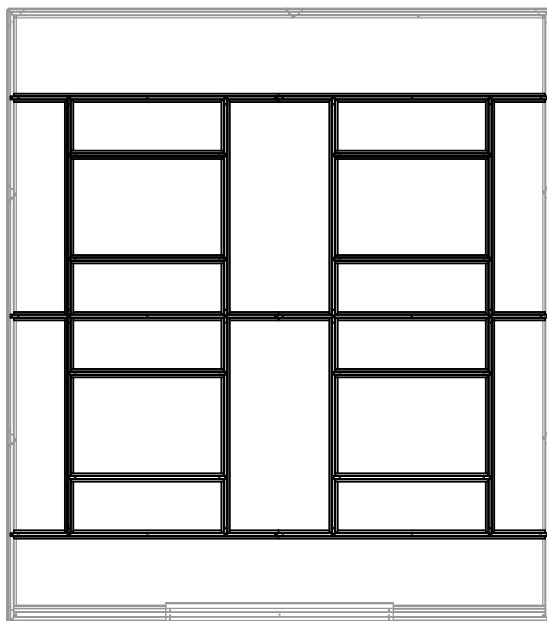
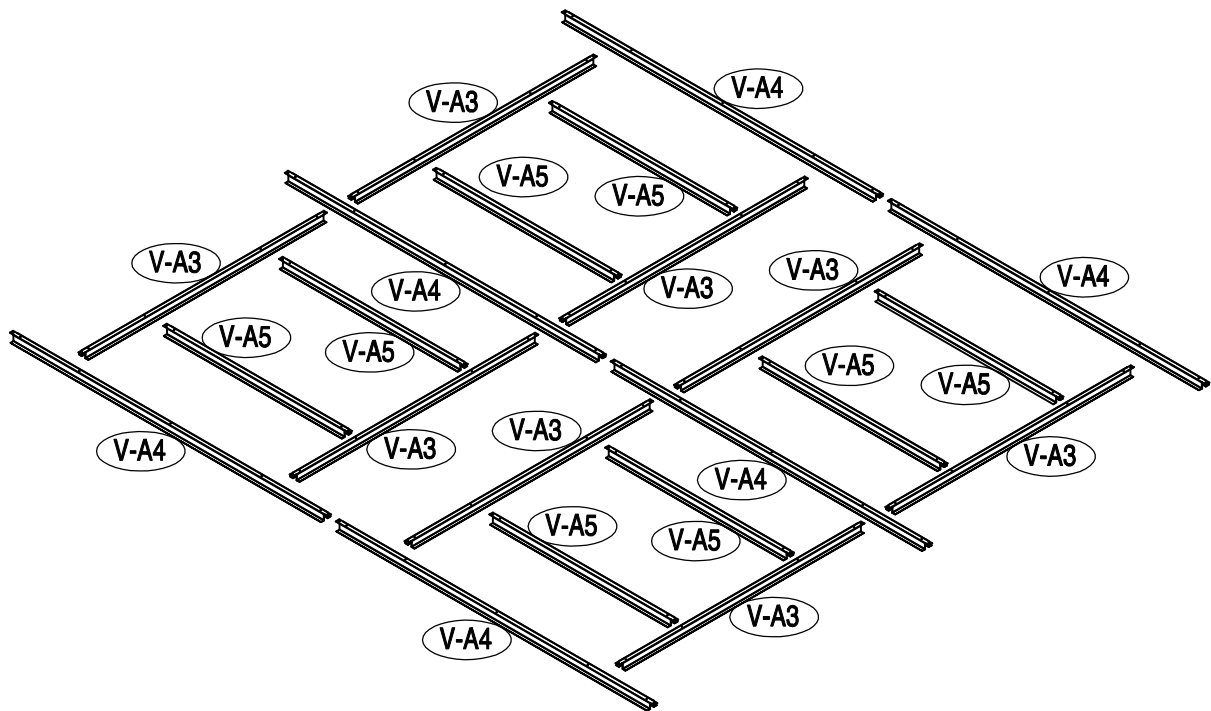

Base		
Part Name	mm	Qty
V-A3	1344	8
V-A4	1663	6
V-A5	969	8
	ST4x10	40



# Kit Before You Begin / Site Preparation

1. Before beginning construction, check local building codes regarding footings, location and other requirements. Study and understand this owner's manual.
2. Follow all directions and dimensions carefully.
3. Follow the step sequence carefully for correct results.
4. Be sure all the parts fit together properly before proceeding.
5. **IMPORTANT:** Remove Owner's Manual from main carton of your storage building.
6. **SAFETY FIRST:** Care must be taken when handling various pieces of your kit since some contain sharp edges. Wear work gloves, eye protection and long sleeves when assembling or performing any maintenance on your kit.
7. **BASIC TOOLS:** No. 2 phillips screwdriver, pliers, work gloves, tape measure, level and a spade or shovel.
8. **GROUND MUST BE LEVEL:** Be sure floor frames lie flat on ground. To prepare earth bed, remove sod and other debris. level the high spots with flat shovel and tamp bed down.
9. **DO NOT STEP ON CHANNELS UNTIL FLOORING MATERIAL IS IN PLACE!**
10. Separate contents of the carton by the part number while reviewing parts list. Check to be sure that you have all the necessary parts for your kit.

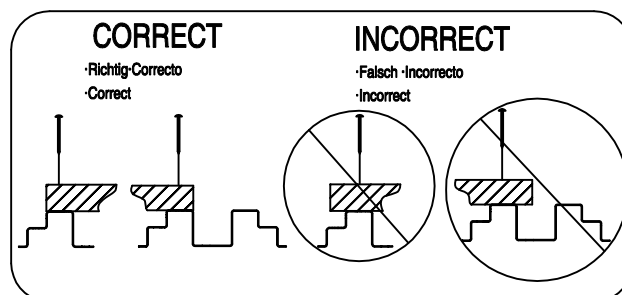

Finish construction of your Storage Building following the Assembly Instructions.

1

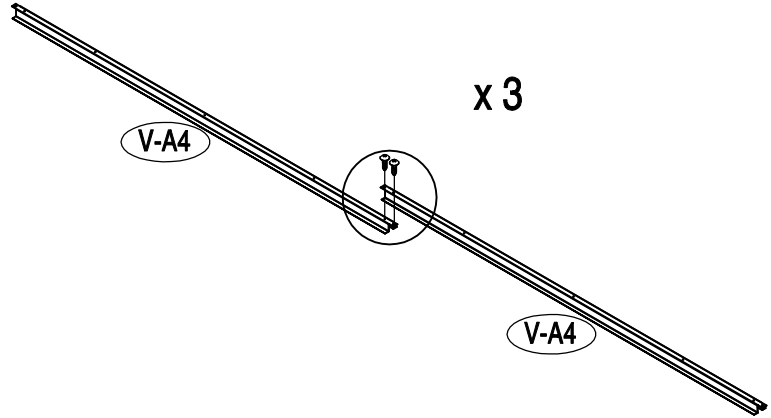
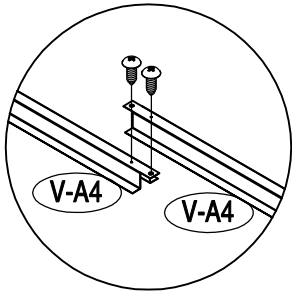

2

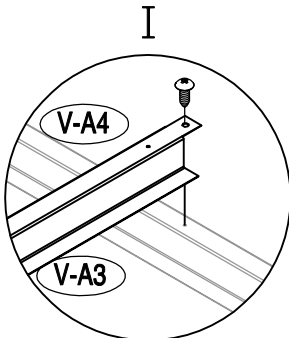

x8

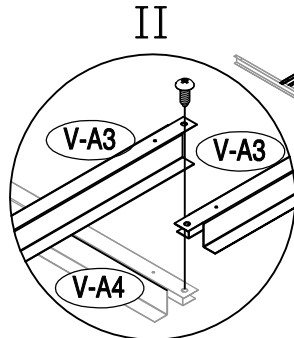

x4

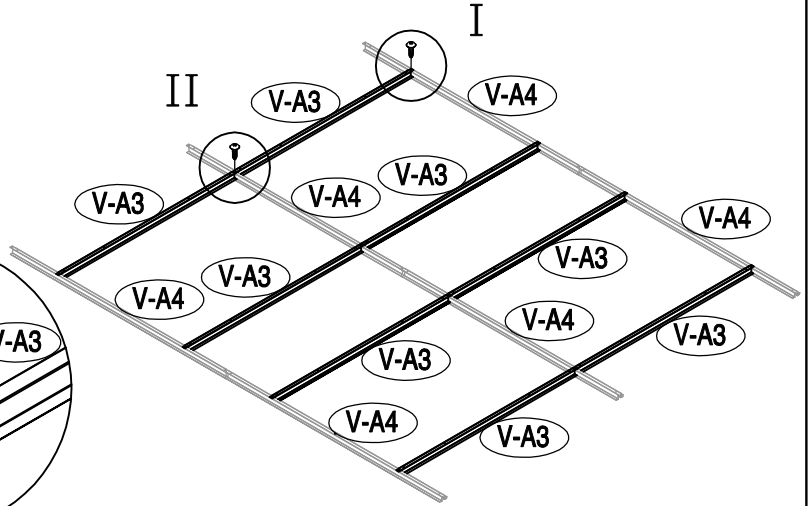

3

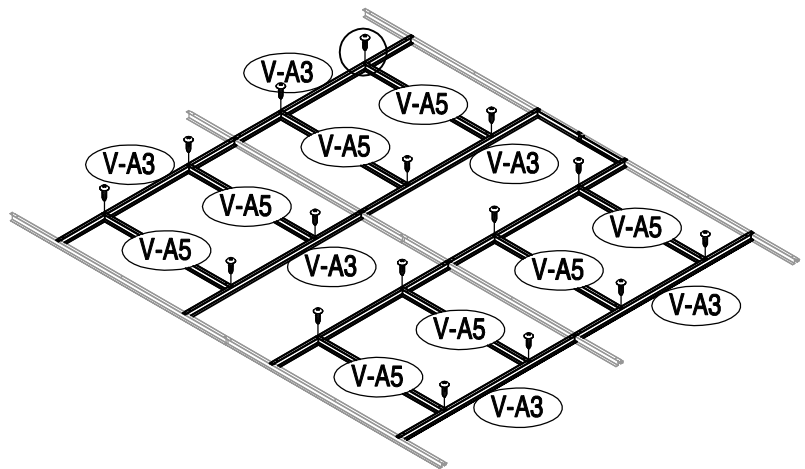
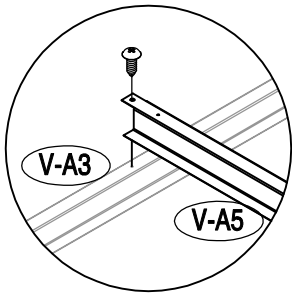

4

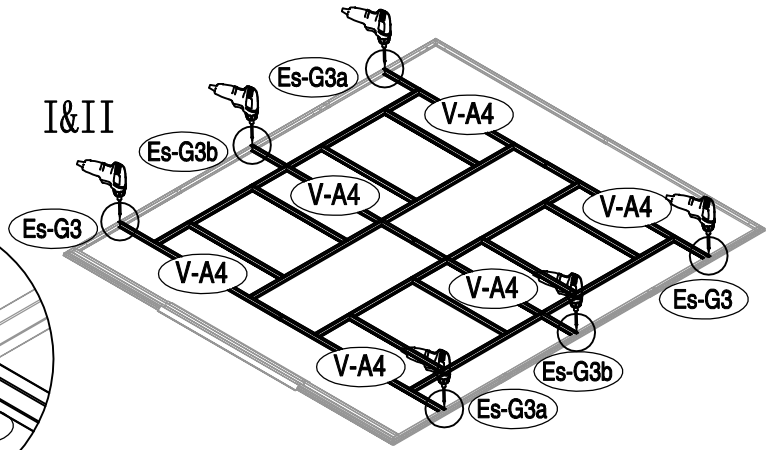
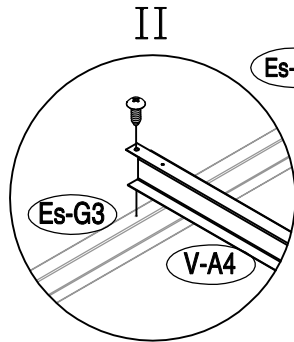
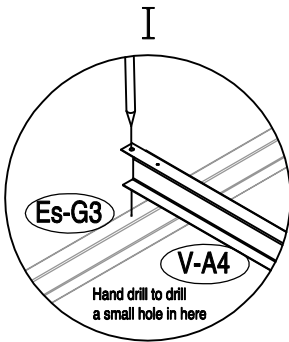

## Contact information

### Head office:

Dancover A/S  
Lyngevej 16A, Nørre Herlev  
3400 Hillerød  
Denmark

For more information  
please visit:

[www.dancovershop.com](http://www.dancovershop.com)

## National contact

### Denmark:

[denmark@dancover.com](mailto:denmark@dancover.com)

### UK:

[uk@dancover.com](mailto:uk@dancover.com)

### Germany:

[germany@dancover.com](mailto:germany@dancover.com)

### France:

[france@dancover.com](mailto:france@dancover.com)

### Sweden:

[sverige@dancover.com](mailto:sverige@dancover.com)

### Finland:

[suomi@dancover.com](mailto:suomi@dancover.com)

### Poland:

[polska@dancover.com](mailto:polska@dancover.com)

### Luxembourg:

[luxembourg@dancover.com](mailto:luxembourg@dancover.com)

### Portugal:

[portugal@dancover.com](mailto:portugal@dancover.com)

### Spain:

[espana@dancover.com](mailto:espana@dancover.com)

### Italy:

[italia@dancover.com](mailto:italia@dancover.com)

### Switzerland:

[schweiz@dancover.com](mailto:schweiz@dancover.com)

### Austria:

[austria@dancover.com](mailto:austria@dancover.com)

### Norway:

[norge@dancover.com](mailto:norge@dancover.com)

### Nederland:

[nederland@dancover.com](mailto:nederland@dancover.com)

### Ireland:

[ireland@dancover.com](mailto:ireland@dancover.com)

### Belgium:

[belgique@dancover.com](mailto:belgique@dancover.com)