

**DANCOVER<sup>®</sup>**













Manual  
for  
Polytunnel Greenhouse  
3x4x2,1m

## THE COMPONENTS OF TUNNEL CONSTRUCTION Aw4

	1,98 m	the tunnel's length	T00064	4 pcs
	1,98 m	bows	T00064	10 pcs
	1,85 m	door frame height	T00089	4 pcs
	1,84 m	door crossbar	T00090	2 pcs
	1,77 m	bows	T00063	5 pcs
	1,675 m	door height	T00087	4 pcs
	1,50 m	the tunnel's width	T00060	4 pcs
	1,30 m	width over door frame	T00091	2 pcs
	1,22 m	door width	T00092	4 pcs
	0,96 m	horizontal elements	T00056	20 pcs

\* length tolerance of the tubes is within ± 1 cm

	Tunnel elbow 32/90	T00002	8 pcs
	Set of screws and washers	Ts0002	1 pcs
	The door handle	T00078	4 pcs + 4 screws + 4 nuts
	Four-way tunnel piece	T00004	15 pcs
	The pin to foil	T00008	72 pcs
	Connecting tube Ø 28 x 0,2 m	T00033	14 pcs
	Tacks	T00200	1 pcs
	Assembly pins	Ts0001	8 pcs

	Corner T-piece	T00001	4 pcs
	Tunnel T-piece 32/32/90	T00005	24 pcs
	Tunnel T-piece 32/32/67	T00030	8 pcs

### USER'S IMPORTANT INFORMATION











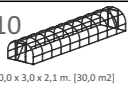
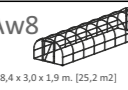
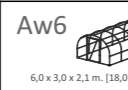

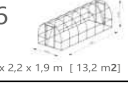

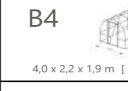
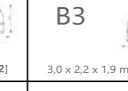
Proper use of the garden tunnel is provided by correct assembly as per the manufacturer's instructions:

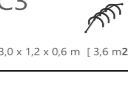
1. The tunnel must be carefully assembled, as per the guidelines in the manual.
2. All elements of the tunnel construction should be carefully secured with tacks in the connections from all sides where the tube joins the fitting.
3. The foil should be assembled on sunny and windless days, which will make the work considerably easier. Firm tightening and stable mounting of the foil is very important, which mainly influences the durability of the material.
4. **During winter periods garden foil should be removed from the construction.**
5. In order to secure the tunnel against difficult weather conditions, the users themselves should additionally strengthen the tunnel by sticking metal or wooden poles and fasten them to the bows.
6. In longer tunnels additional reinforcement of the whole construction is recommended, through connection of particular bows in their upper part with the use of an additional tube or a thick wire (the so-called ridge lath)
7. The tunnel's construction may additionally be reinforced using polypropylenic string that will be winding crossly the tunnel's surface and that will be fastened to the metal hooks at the ground.
8. Don't leave the tunnel opened at strong wind, because it may cause the damage of particular parts of the tunnel.
9. One should not attach the strings supporting the plants to the bows, because it may cause the damage of particular parts of the tunnel.
10. The garden tunnel should not be placed in the open space. It should be placed near the buildings or trees and bushes.
11. During the assembly the ambient temperature should not be lower than 10°C.

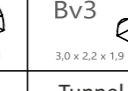
**THE MANUFACTURER is not responsible for improper use of the tunnel, other than intended use and for the damages that occurred as a result of extreme weather conditions, such as strong wind, hailstorm, snow etc.**

- Internal layer ensures increased thermal insulation properties, which results in keeping greater amount of thermal radiation inside the tunnel.
- External layers ensure:
- proper elasticity, increased durability and resistance to damages and perfect permeability of light.
- Advantages of five-layered foil**
- perfect mechanic durability (addition of metallocene)
  - perfect permeability of daylight
  - high elasticity and resistance to low temperatures
  - ensuring the greenhouse effect

### ADDITIONALLY ON OFFER

 Aw10 10,0 x 3,0 x 2,1 m [30,0 m <sup>2</sup> ]	 Aw8 8,4 x 3,0 x 1,9 m [25,2 m <sup>2</sup> ]	 Aw6 6,0 x 3,0 x 2,1 m [18,0 m <sup>2</sup> ]	 Aw4 4,0 x 3,0 x 2,1 m [12,0 m <sup>2</sup> ]	
 B6 6,0 x 2,2 x 1,9 m [13,2 m <sup>2</sup> ]	 B5 5,0 x 2,2 x 1,9 m [11 m <sup>2</sup> ]	 B4 4,0 x 2,2 x 1,9 m [8,8 m <sup>2</sup> ]	 B3 3,0 x 2,2 x 1,9 m [6,6 m <sup>2</sup> ]	 B2 2,0 x 2,2 x 1,9 m [4,4 m <sup>2</sup> ]
 C6 6,0 x 1,2 x 0,6 m [7,2 m <sup>2</sup> ]	 C3 3,0 x 1,2 x 0,6 m [3,6 m <sup>2</sup> ]	 Bv2 2,0 x 2,2 x 1,9 m [4,4 m <sup>2</sup> ]	 Bv3 3,0 x 2,2 x 1,9 m [6,6 m <sup>2</sup> ]	 Bv4 4,0 x 2,2 x 1,9 m [8,8 m <sup>2</sup> ]
 Rainwater recovery system	 Tunnel pipes	 Tunnel parts	 Tunnel foils	

## Foil Tunnel

Area: 12 m<sup>2</sup>

4,0 x 3,0 x 2,1m

Construction: PVC Ø 32 mm

Foil Uv4



We wish You  
plentiful  
and delicious  
crops.

# Assembly instruction



Min. 10°C



∅ 2 mm



## 1. The tunnel's frame

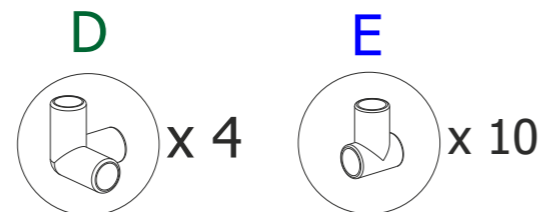
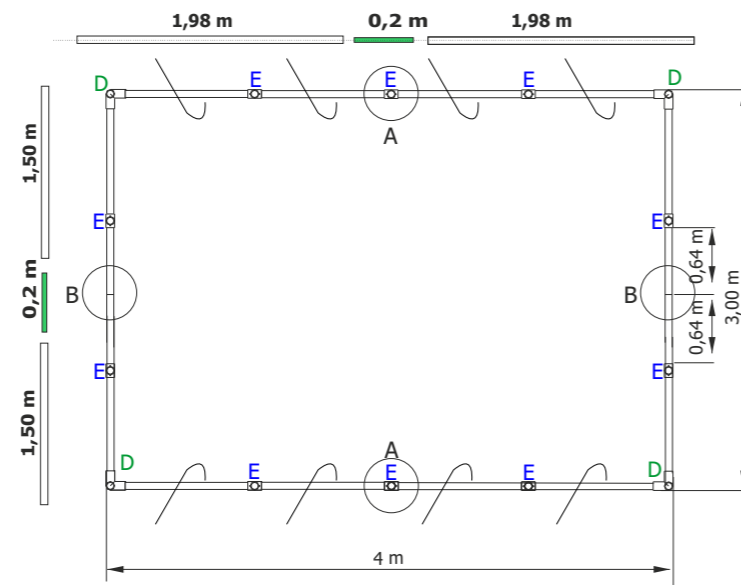
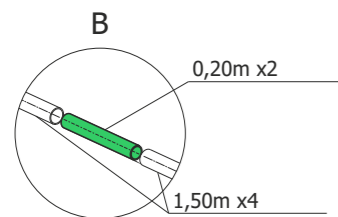
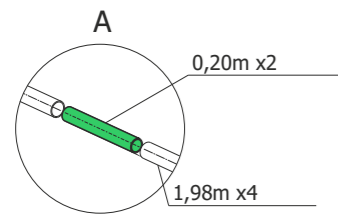

## 3. The tunnel's door

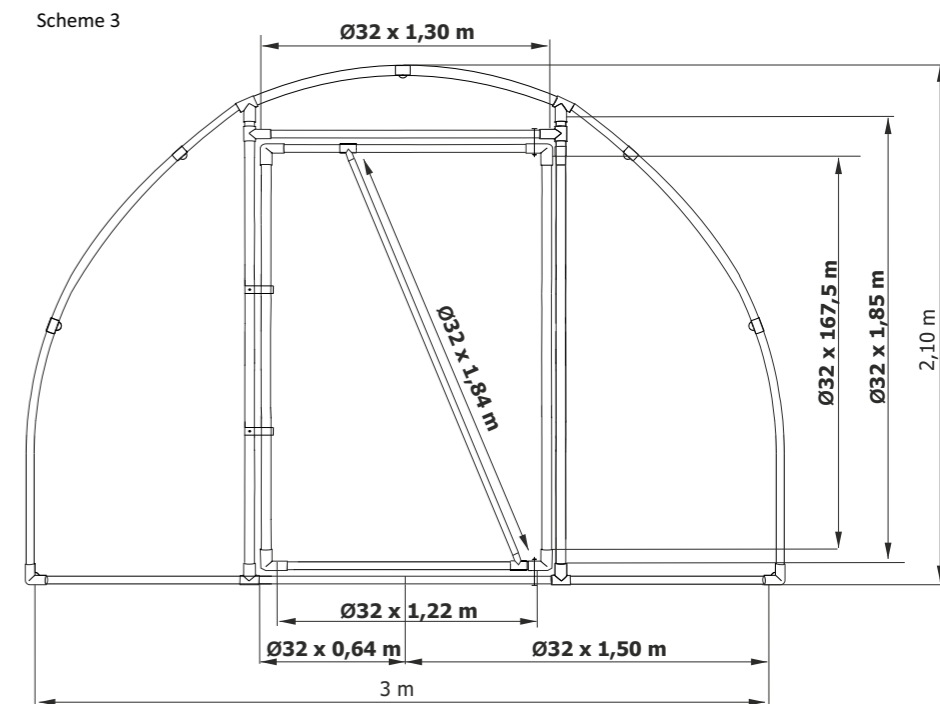
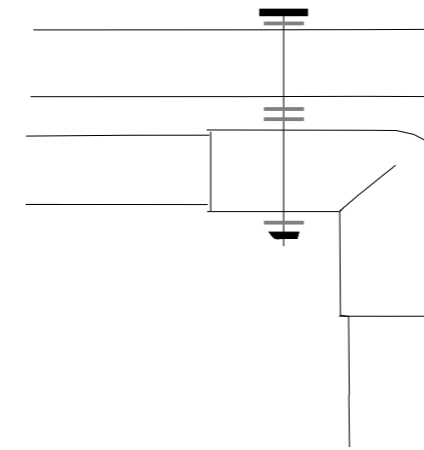

## 2. The tunnel's bows

Scheme 2a



Scheme 2b

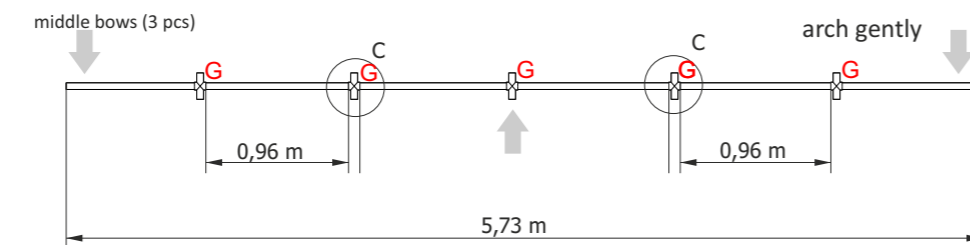

the bow at the front and back of the tunnel (2 pcs)

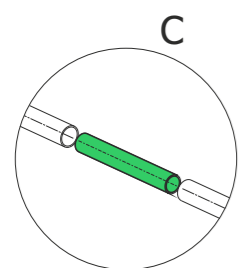
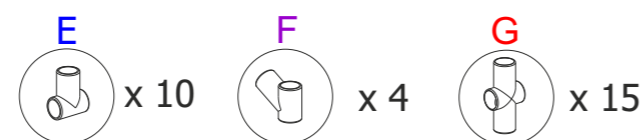
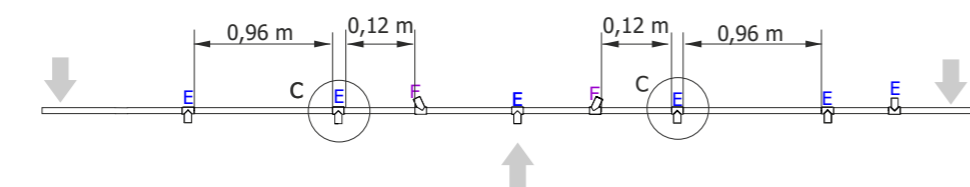

## 4. Assembly of the foil

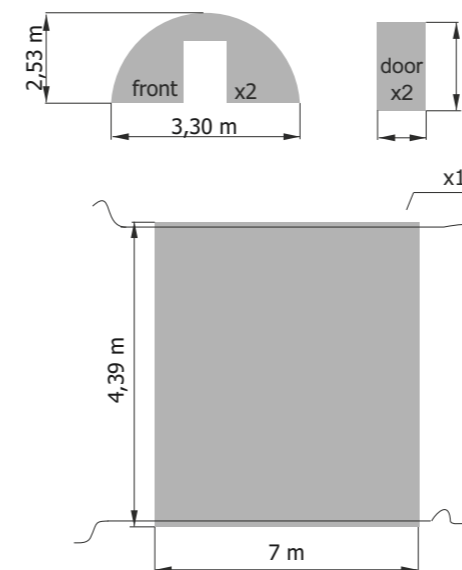

Scheme 4

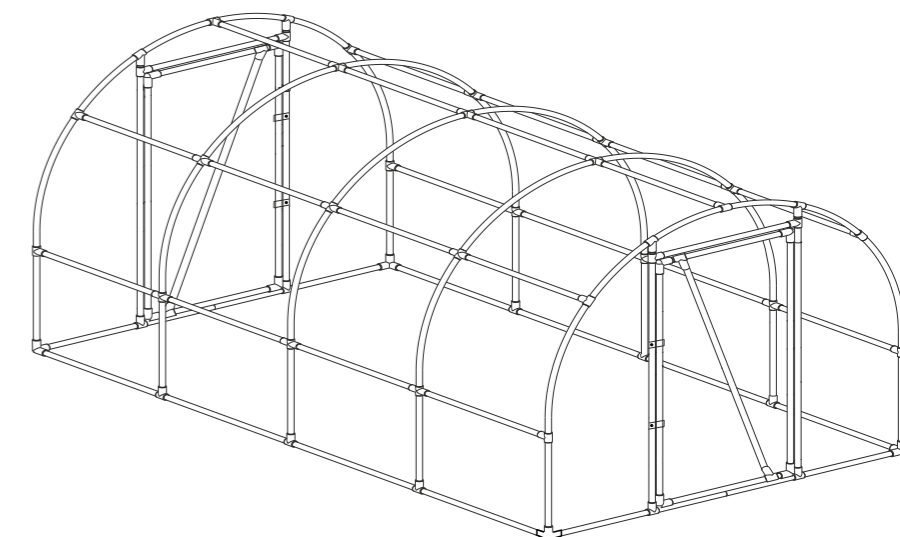

# DANCOVER<sup>®</sup>

.com

## Contact information

Austria



Belgium



Croatia



Denmark



Estonia

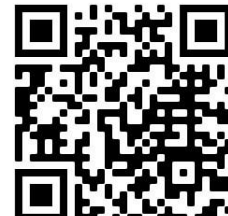

Finland



France



Germany



Ireland



Italy



Latvia



Lithuania



Nederland



Norway



Poland



Portugal



Spain



Sweden



Switzerland



UK



For more information please visit: [www.dancovershop.com](http://www.dancovershop.com)