

**DANCOVER<sup>®</sup>** The logo for DANCOVER.com, featuring the word "DANCOVER" in a bold, black, sans-serif font with a registered trademark symbol (®) to the right. To the right of the text is a red vertical rectangle containing the text ".com" in white, oriented vertically.

Manual

Event & display package no. 3

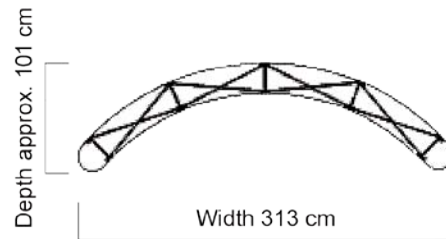
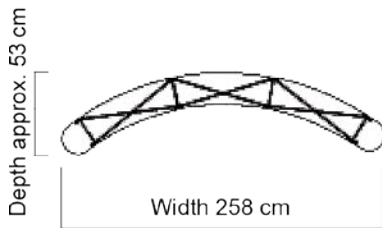
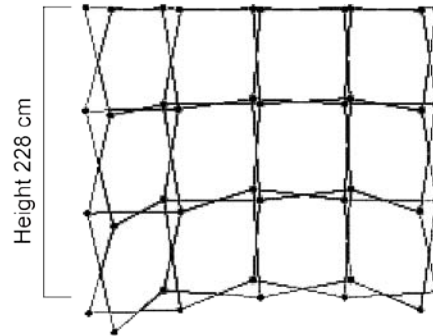
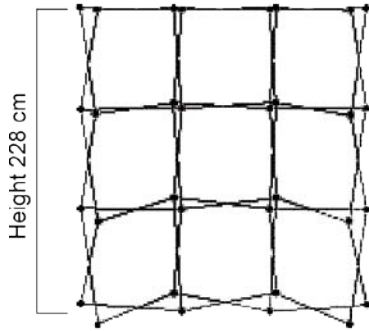
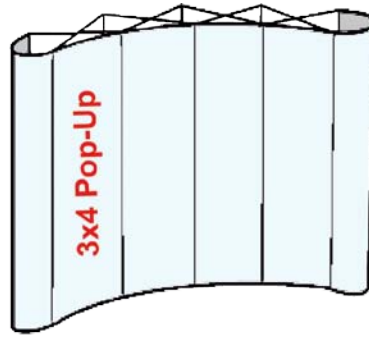
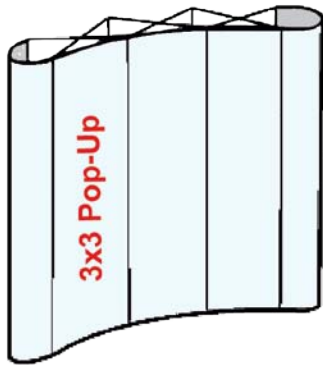

**3 x 3 Pop-Up Curved: Printing Panel Sizes**

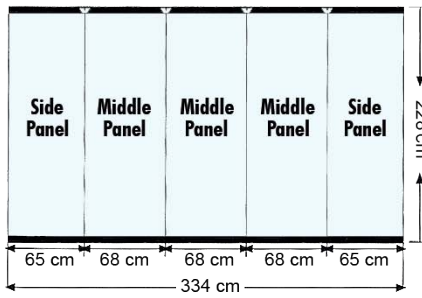

**3 x 4 Pop-Up Curved: Printing Panel Sizes**

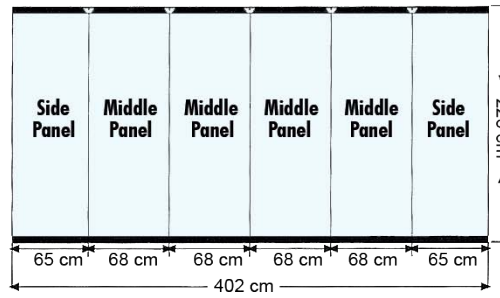

COUNTER TOP PLATE

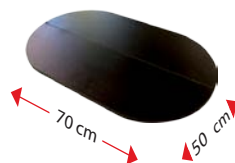



The Pop-up presentation walls are delivered in a cart board box.  
Do not open the box with a knife or sizzers!!! You might damage the suitcase.



In the packaging you find the transportation suitcase.



On the backside of the suitcase there is a grip which you can pull out, by tilting the suitcase you can easily roll the suitcase.



Open the suitcase by turning the openers on both sides  
Content see image 6.



1x Pop-up wall  
PVC sheets (3x3=5 pieces 4x3=6 pieces)  
Connection peices (3x3=18 pieces 4x3=21 pieces)  
1x Roll self adhesive magnetic tape  
Transportation suitcase  
hanging block (3x3=6 pieces 4x3=7 pieces)  
Hanging strips with slot (3x3=5 pieces 4x3=6 pieces)  
Hanging strips with cut-out piece (3x3=5 pieces 4x3=6 pieces)

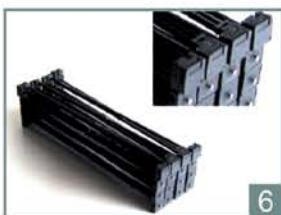

Lay down the Pop-up in such a way that the side with the 4 or 5\* thick blocks on a row is on top, this will be the front side.  
\*4 or 5 depending on 3x3 or 3x4



Pull up the system half way, now you can easily mount the other pieces.



This is a thick block on the top side.

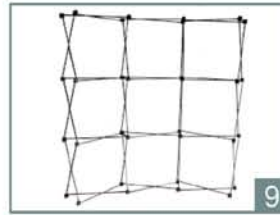

Pull up the system so that it unfolds completely.



These are the hanging strips with slot and with cut-out piece.



The hanging strip with slot comes on top of the PVC sheet, the hanging strip with cut-out piece on the bottom.



The hanging strips with slot and with cut-out piece are delivered in 2 lengths. The short ones are for the outside sheets of the wall (the curved sheets).



Connection pieces



First place a conection piece on the bottom.



Slide the block on to the bottom block of the pop-up with the metal pin.



Take another connection piece and slide the point into the top block of the pop-up.



Slide the bottom block of the connection piece on the block below of the pop-up.



Slide the middle connection piece into the top connection piece block and the bottom connection piece into the middle connection piece block. Now slide the block onto the block with the metal pin of the pop-up.



One standing piece is now complete, repeat step 26 till 30 for the other standing pieces.



Attention: the PVC sheets are oversized!!! And have to be cut to the right size. The breadth of the hanging strip determines the breadth of the image.



Here you see clearly that the PVC sheet is wider than the hanging strip. This is done to make mounting the full-colour-print easier. The length you should measure in the system.



Mount the full-colour-print on the PVC sheet.



After mounting cut away the unnecessary strips.

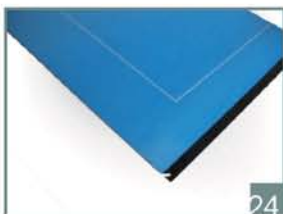

Now that the full-colour-print is mounted and cut, the sheet has the breadth of the particular hanging strip.



The hanging strip with slot you put on the topside of the sheet, the hanging strip with cut-out piece on the bottomside. Mounting is done by the self adhesive strip.



Now mount on the backside of sheet the self adhesive magnetic strip on the long sides of the sheet. Now the sheet is ready.



Hang the PVC sheet in the hanging blocks on the top-side.



The sheet stays in place by means of the magnetic strips and the hanging strips. Repeat the procedure for the other sheets.



Spots are optional 29

The system is delivered with a 3-pole plug, possibly you have to replace this one with another plug.



Spots are optional 30

You can also mount the halogen lamps on the legs of the system as shown. The light will be closer to you presentation.

### 3x3 Pop-up

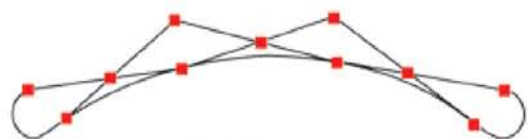

### 3x4 Pop-up

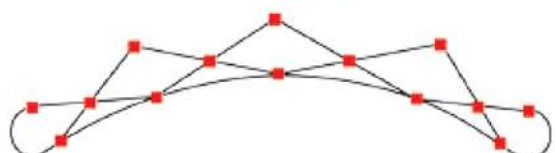



Print for hardcase/counter

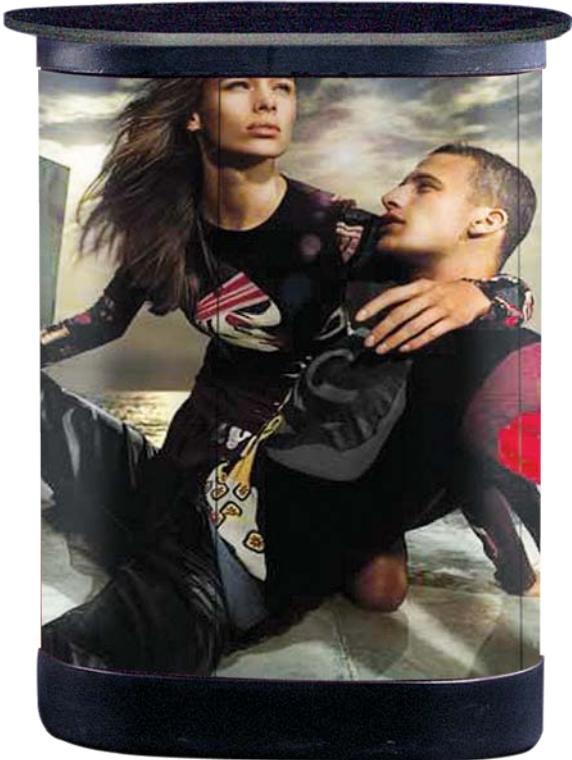

Carrying capacity top: 30 kg

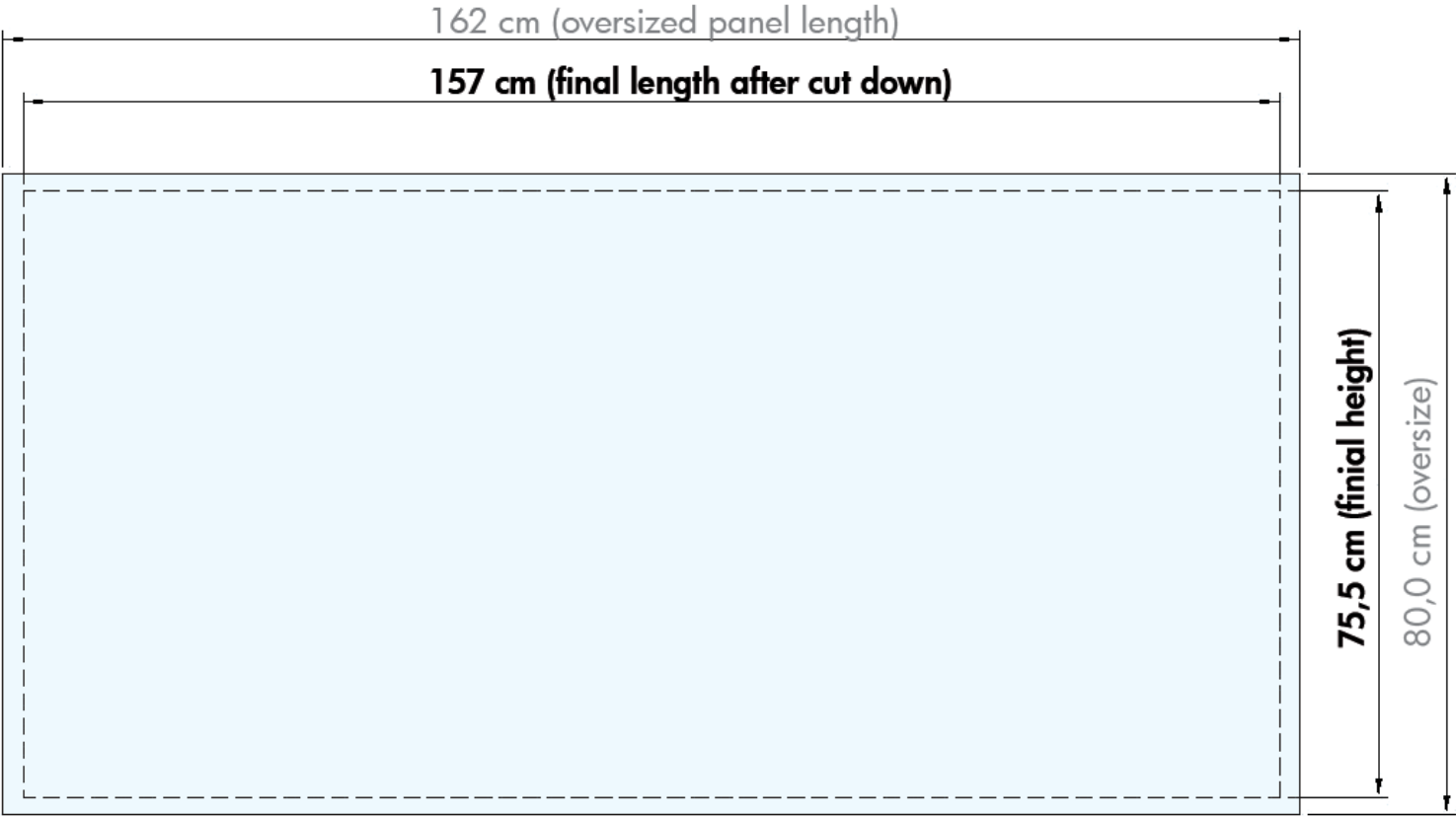

A

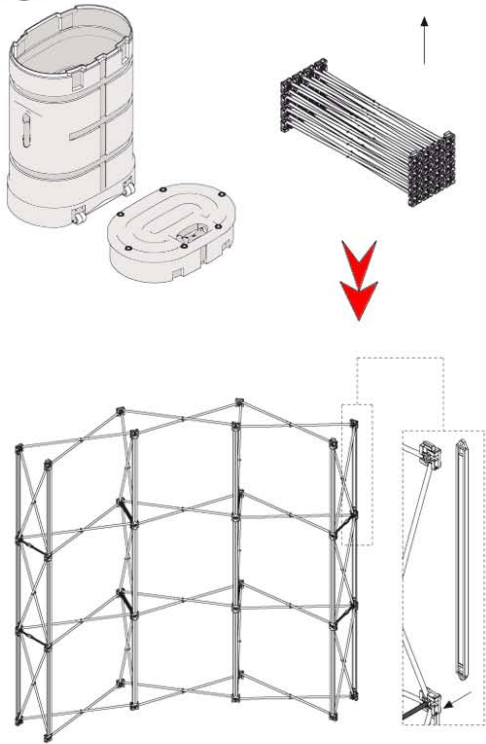

## Instruction of assembly / Montageanleitung

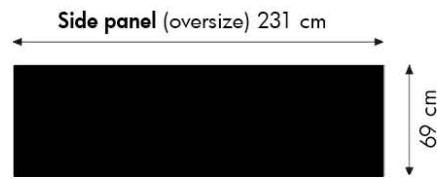

GB Side panel thickness 0,4 mm  
DE Seitenpaneel Dicke 0,4 mm



GB Black strap with slot and tape (0,8 mm) for side panels  
DE Schwarze Strapleiste mit Schlitz und Klebeband (0,8 mm) für Seitenpaneel



GB Black strap with tape (0,8 mm) for side panels  
DE Schwarze Strapleiste mit Klebeband (0,8 mm) für Seitenpaneel

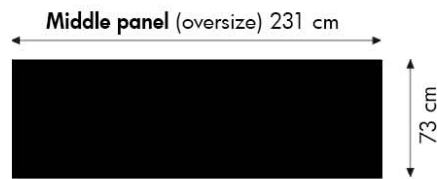

GB Middle panel thickness 0,6 mm  
DE Mittleres Paneel Dicke 0,6 mm



GB Black strap with slot and tape (2 mm) for middle panels  
DE Schwarze Strapleiste mit Schlitz und Klebeband (2 mm) für Mittlere Paneel



GB Black strap with tape (2 mm) for middle panels  
DE Schwarze Strapleiste mit Klebeband (2 mm) für Mittlere Paneel

## Final dimensions after trimming of print / Endgültige Abmessungen nach dem Beschneiden von Print

B

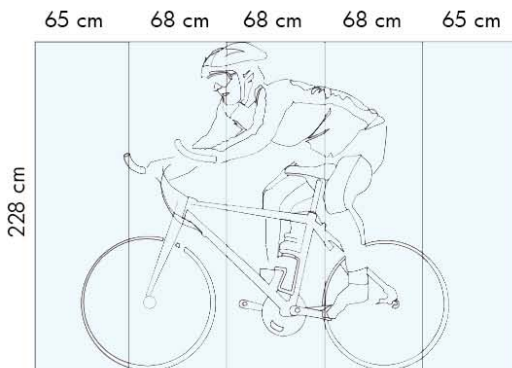

	Thin panel 0,4 Dünnere Paneel	Thick panel 0,6 Dicker Paneel
3 x 3 Pop-Up	2 pcs. / Stück	3 pcs. / Stück
3 x 4 Pop-Up	2 pcs. / Stück	4 pcs. / Stück



GB Roll with magnetic tape  
DE Rolle mit magnetische Klebeband

## Oversized panels mounted with print / Paneel in Übermaß mit Druck montiert

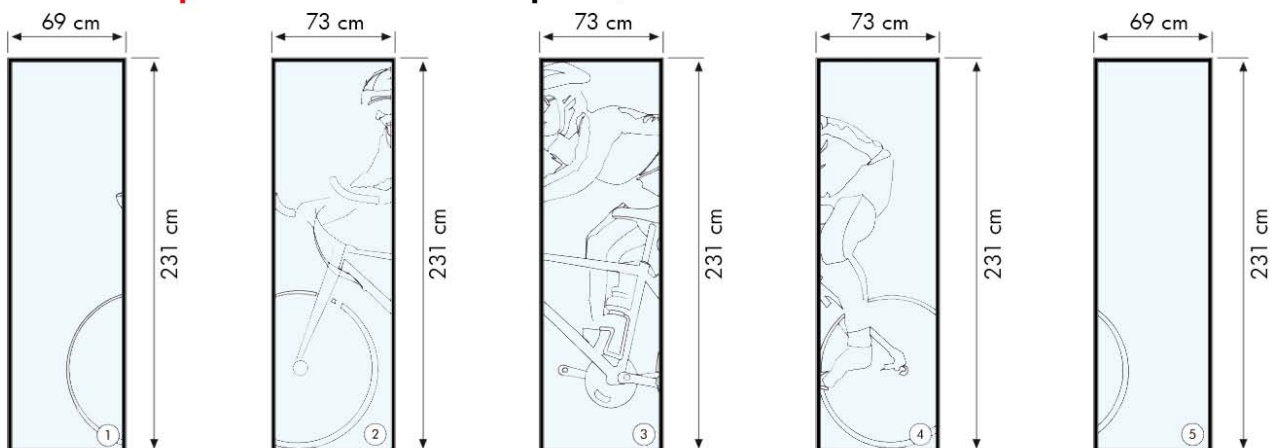

GB Side panel (thin)  
Thickness 0,4 mm  
DE Seitenpaneel (dünn)  
Dicke 0,4 mm

GB Middle panel (thick)  
Thickness 0,6 mm  
DE Mittleres Paneel (dick)  
Dicke 0,6 mm

GB Middle panel (thick)  
Thickness 0,6 mm  
DE Mittleres Paneel (dick)  
Dicke 0,6 mm

GB Middle panel (thick)  
Thickness 0,6 mm  
DE Mittleres Paneel (dick)  
Dicke 0,6 mm

GB Side panel (thin)  
Thickness 0,4 mm  
DE Seitenpaneel (dünn)  
Dicke 0,4 mm

### C Cutting of side panels (2 pcs. 0,4 mm) / Schneiden von Seitenpaneele (2 Stück 0,4 mm)

- Cut on right measurement with tools carefully not to damage the printing.
- Um den Druck auf der PVC Panele nicht zu beschädigen bitte je nach Mass schneiden.

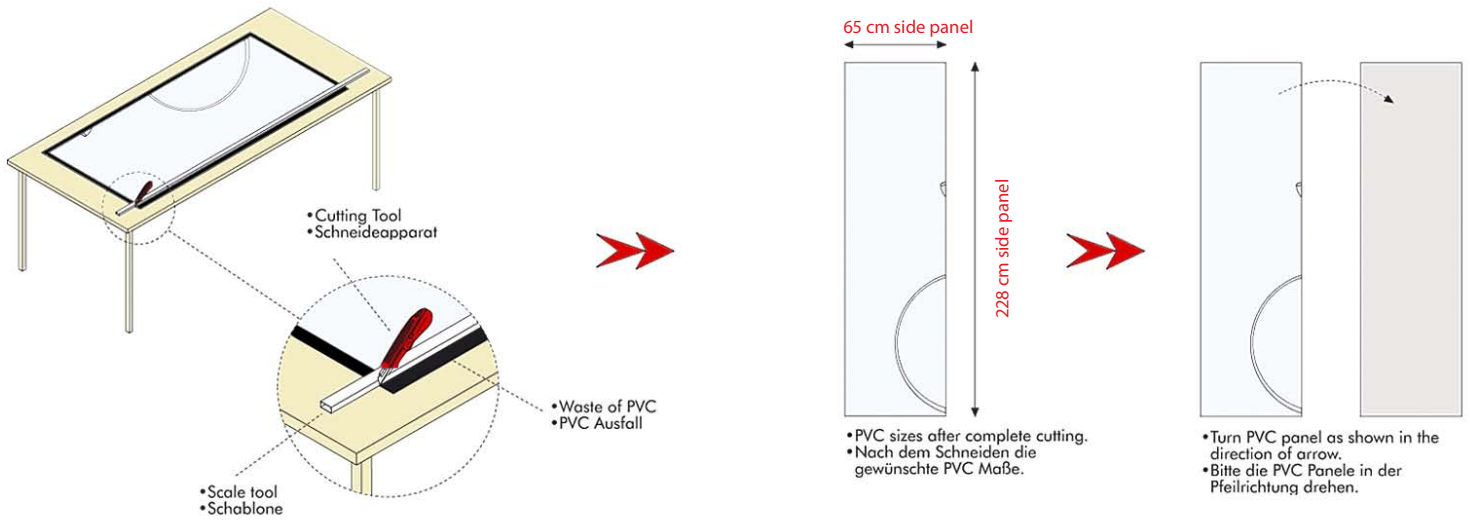

### D Please fixate as shown / Bitte Fixieren nach Abbildung

- Fix thin PVC straps with and without slot as shown, cut form over PVC strap with slot by a cutting tool off from PVC panel.
- Dünne mit und ohne Kanäle PVC Streifen, je nach Beschreibung fixieren und über den PVC Streifen mit den Kanal befundenen Form mit Hilfe der Schneideapparat auf dem PVC Panel schneiden.

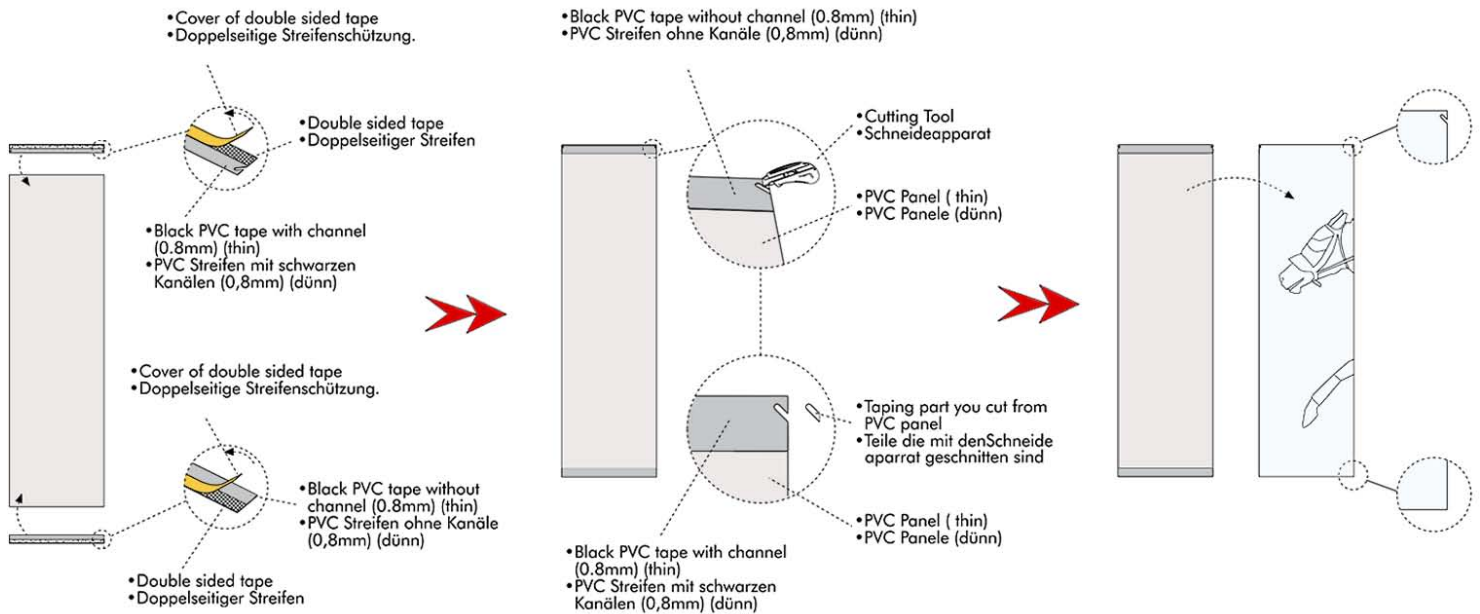

## E Cutting of middle panels (3 or 4 pcs. 0,6 mm) / Schneiden von Mittlerer Paneele (3 oder 4 Stück 0,6 mm)

- Cut PVC on right measurement with tools carefully not to damage the printing.
- Ohne den Druck auf dem PVC Panele zu beschädigen mit den Hilfsmitteln sorgfältig je nach Mass schneiden.

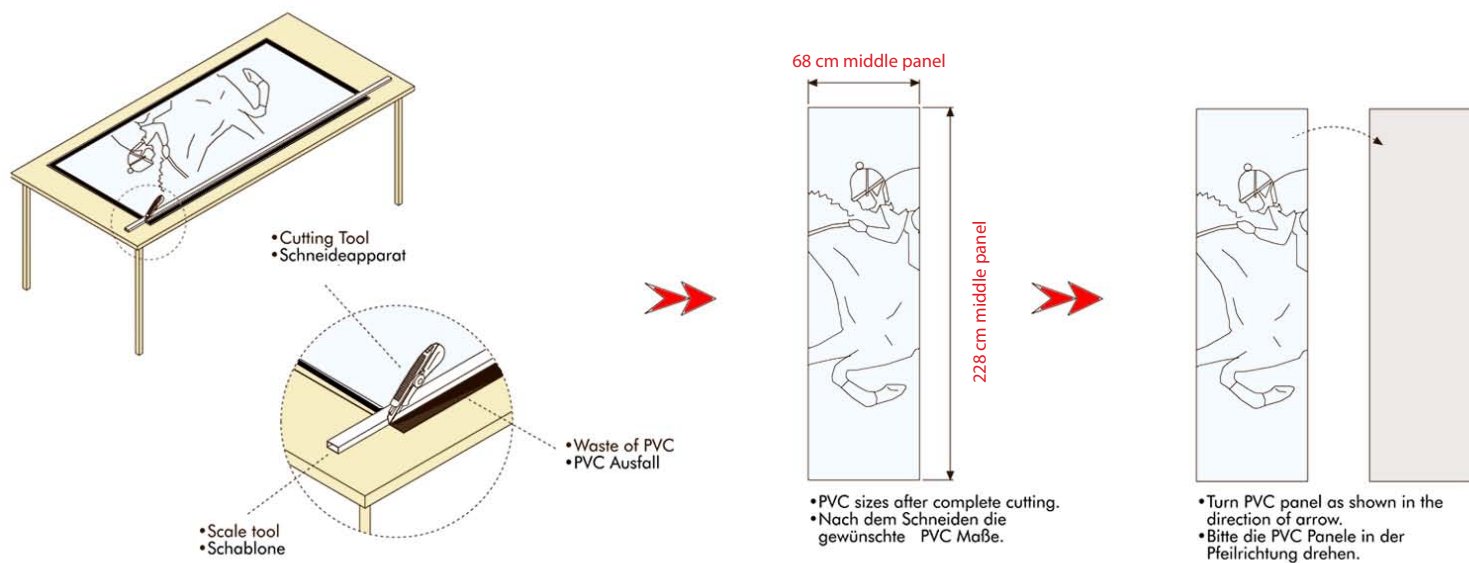

## F Please fixate as shown / Bitte Fixieren nach Abbildung

- Fix thick PVC straps with an without slot as shown, cut form over PVC strap with slot by a cutting tool off from PVC panel.
- Dicke mit und ohne Kanäle PVC Streifen je nach Beschreibung fixieren und über den PVC Streifen mit Kanal befundenen Form mit Hilfe den Schneideapparat auf dem PVC Panel schneiden.

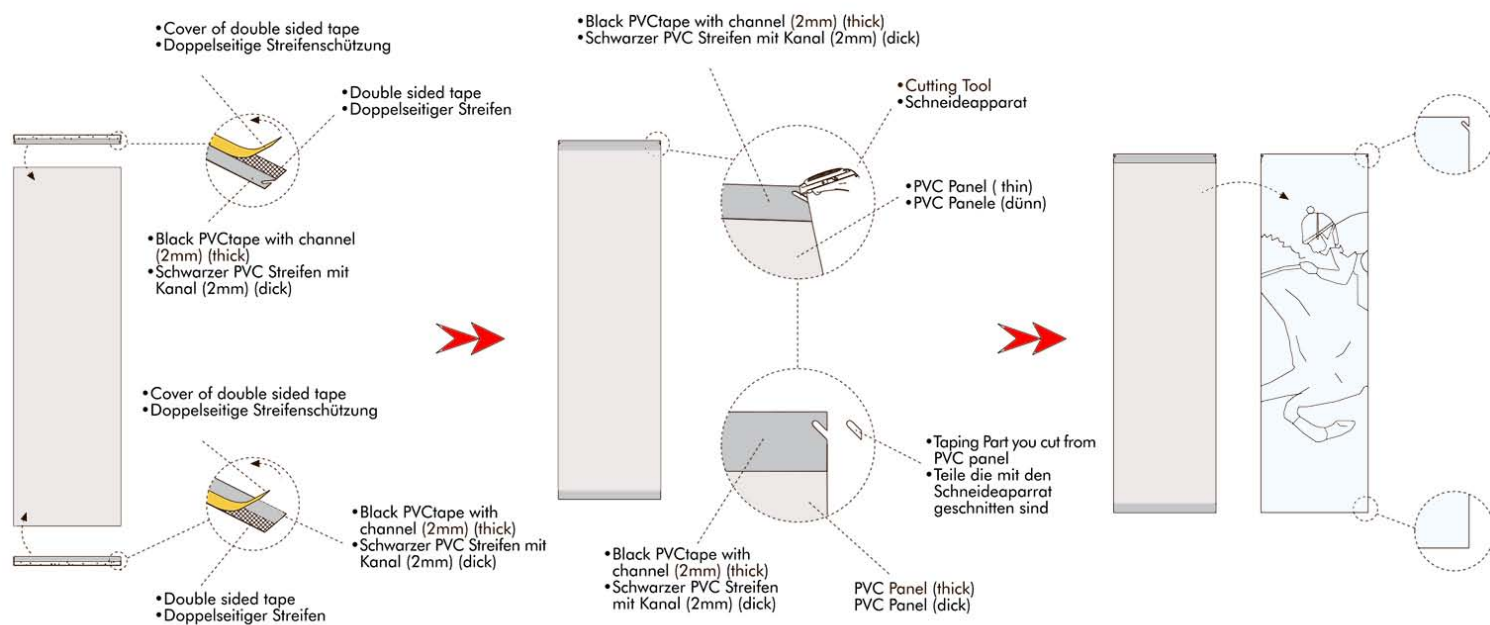



## G Apply magnetic sticker / Montierung von magnetische Klebeband

- Step: Fixate magnetic band giving some free space from up and side. Apply this procedure for the other panels also.
- Step: Von oben und unten Einlage haben und mit der magnetischer Klebung fixieren. Diese Aktion bei den weiteren Panelen Ausführen.

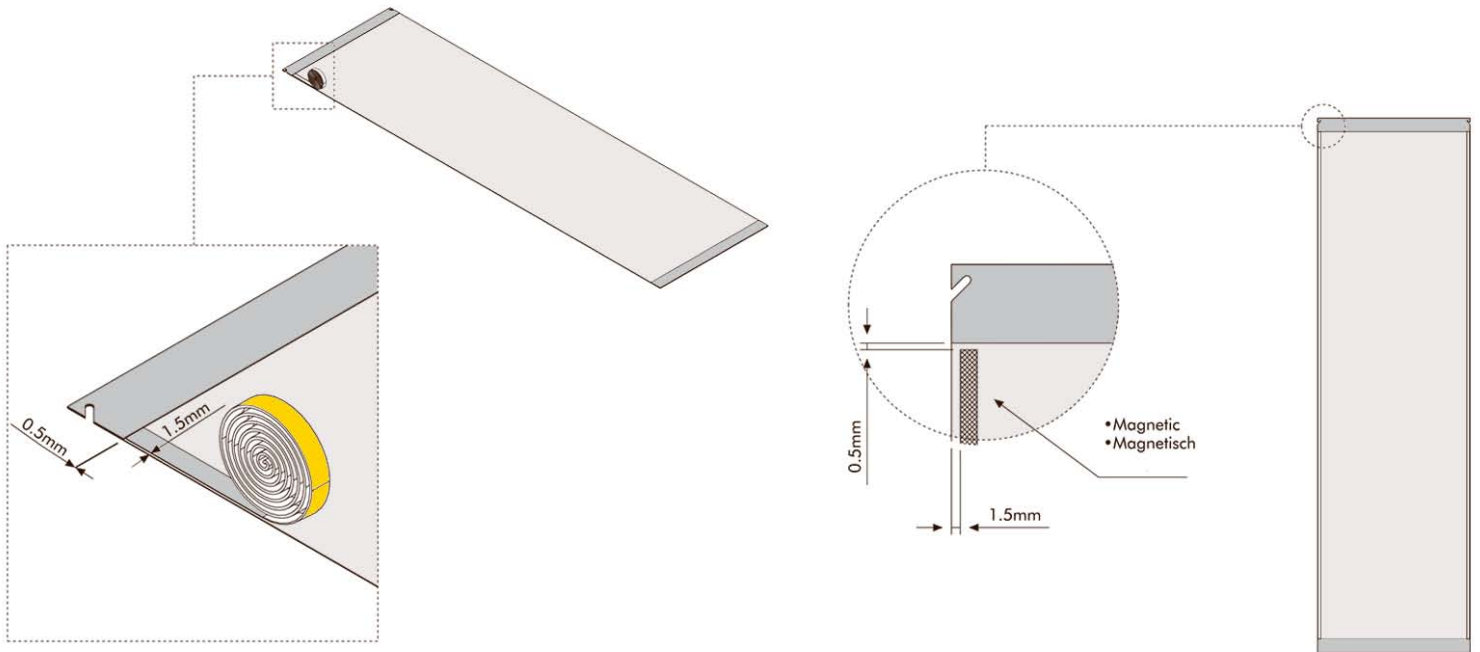

## H Apply the panels / Die Paneele montieren

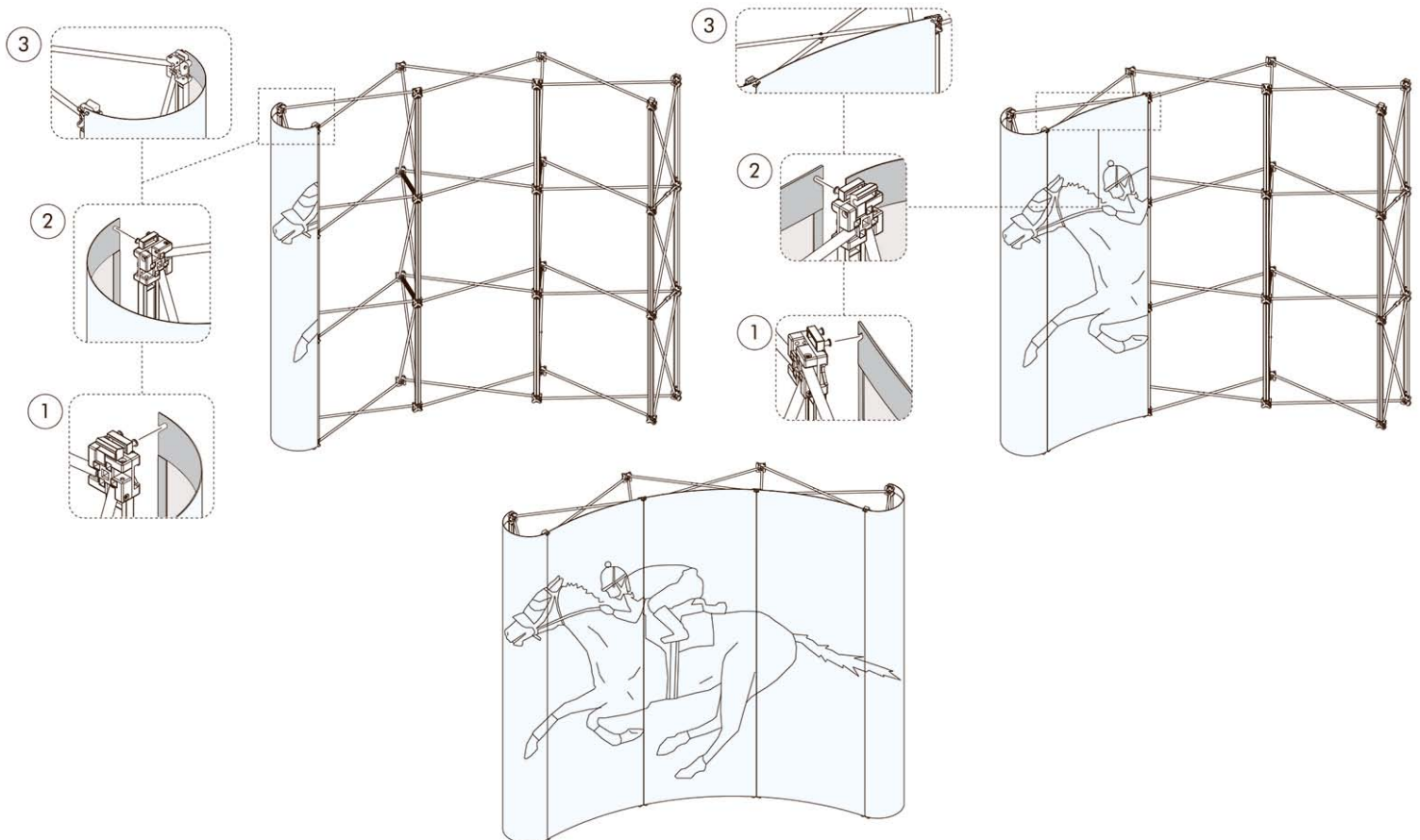

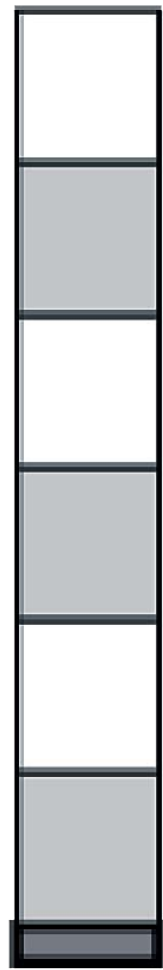

Height 145 cm

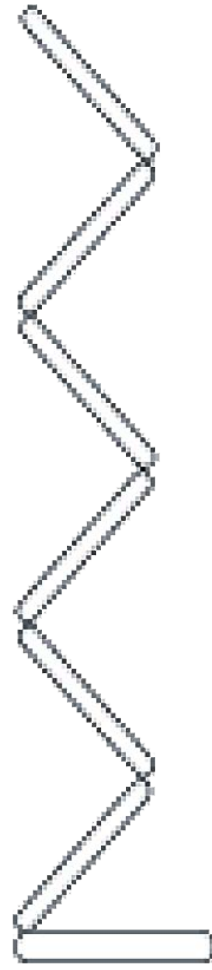

Width 27 cm

Depth 36 cm



## Contact information

### Head office:

Dancover A/S  
Nordre Strandvej 119 G  
3150 Hellebæk  
Denmark

For more information  
please visit:  
[www.dancovershop.com](http://www.dancovershop.com)

## National contact

Denmark: 70 26 76 20  
[denmark@dancover.com](mailto:denmark@dancover.com)

UK: 020 8099 7570  
[uk@dancover.com](mailto:uk@dancover.com)

Germany: 041 0266 7040  
[germany@dancover.com](mailto:germany@dancover.com)

France: 0975 181 800  
[france@dancover.com](mailto:france@dancover.com)

Sweden: 040 233 262  
[sverige@dancover.com](mailto:sverige@dancover.com)

Finland: 0 931 581 720  
[suomi@dancover.com](mailto:suomi@dancover.com)

Poland: 22 300 8602  
[polska@dancover.com](mailto:polska@dancover.com)

Luxembourg: +49 041 0266 7040  
[luxembourg@dancover.com](mailto:luxembourg@dancover.com)

Portugal: 308 800 899  
[portugal@dancover.com](mailto:portugal@dancover.com)

Spain: 911 436 828  
[espana@dancover.com](mailto:espana@dancover.com)

Italy: 02 479 21 198  
[italia@dancover.com](mailto:italia@dancover.com)

Switzerland: 0840 000125  
[schweiz@dancover.com](mailto:schweiz@dancover.com)

Austria: 0662 626935  
[austria@dancover.com](mailto:austria@dancover.com)

Norway: 231 00 690  
[norge@dancover.com](mailto:norge@dancover.com)

Nederland: 0 858 880 524  
[nederland@dancover.com](mailto:nederland@dancover.com)

Ireland: 0 151 33 003  
[ireland@dancover.com](mailto:ireland@dancover.com)

Belgium: 0 28 08 08 09  
[belgique@dancover.com](mailto:belgique@dancover.com)