

DANCOVER[®]

.com

Manual
for
Finial & Casting f/Orangery
4,45x4,45x2,52m

Optional Cresting and Finials

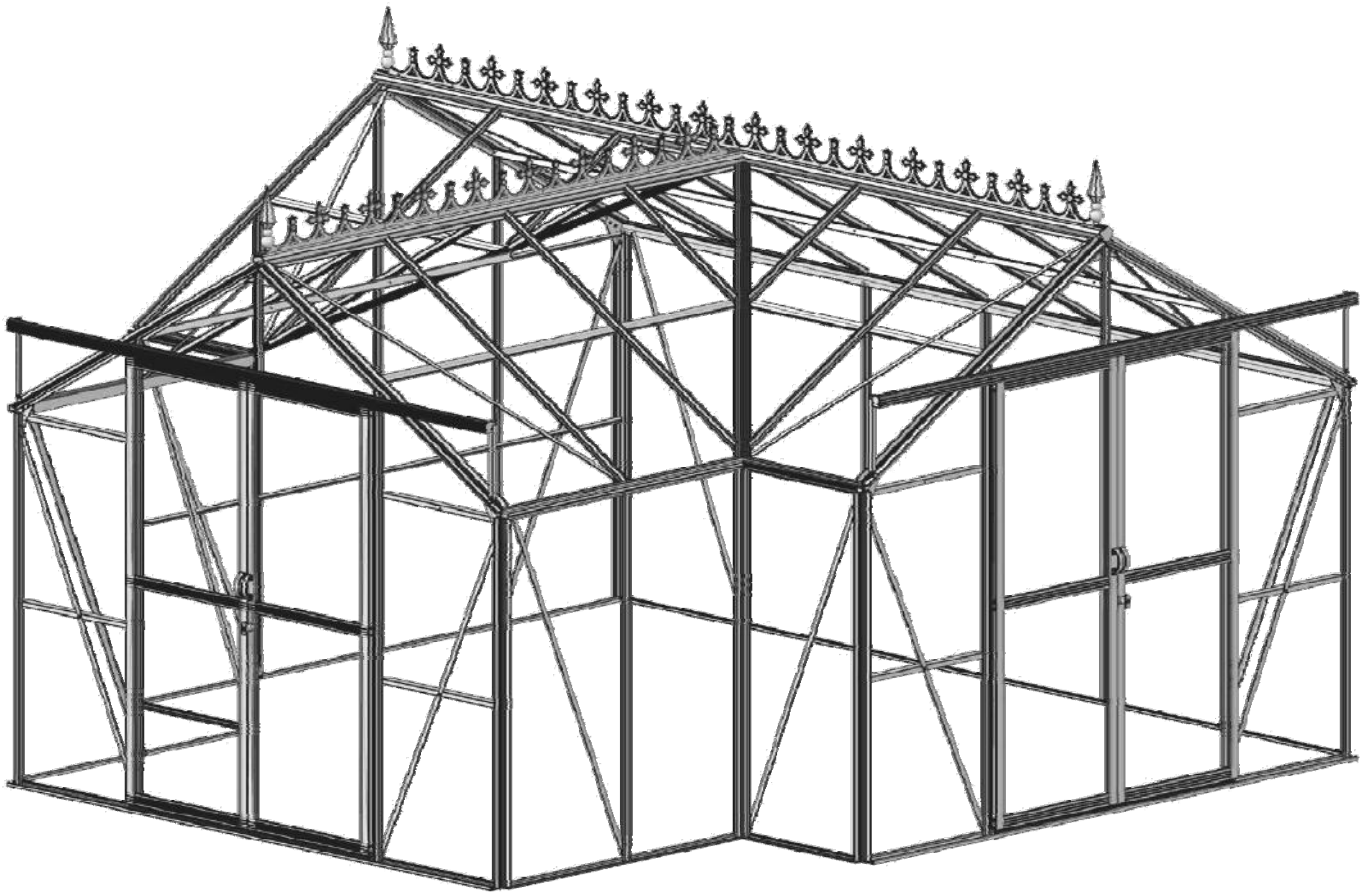

CAUTION:

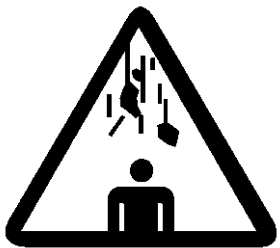

Once finial in position, please immediately drill a 4mm hole on ridge and **fix** finial with M4x12 bolt and nut to avoid finial falling off to injure people.

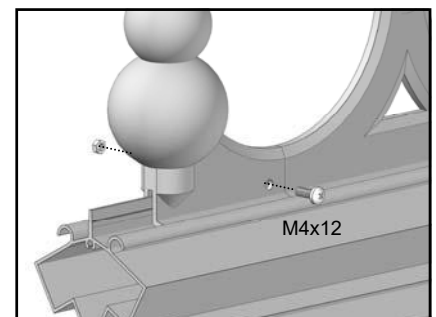
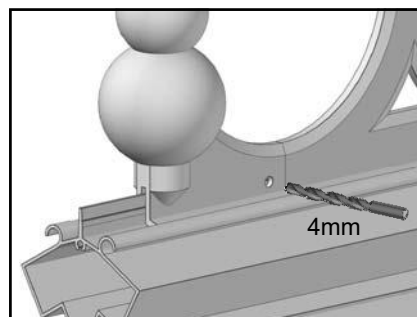
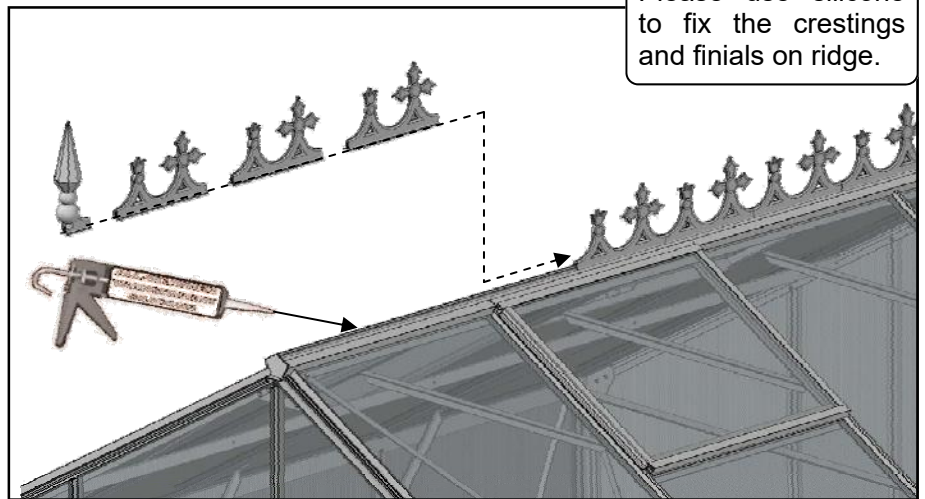

Contact information

Austria



Belgium



Croatia



Denmark



Estonia



Finland



France



Germany



Ireland



Italy



Latvia



Lithuania



Nederland



Norway



Poland



Portugal



Spain



Sweden



Switzerland



UK

